

# BAYLINER<sup>®</sup>

## VR5 / VR5E

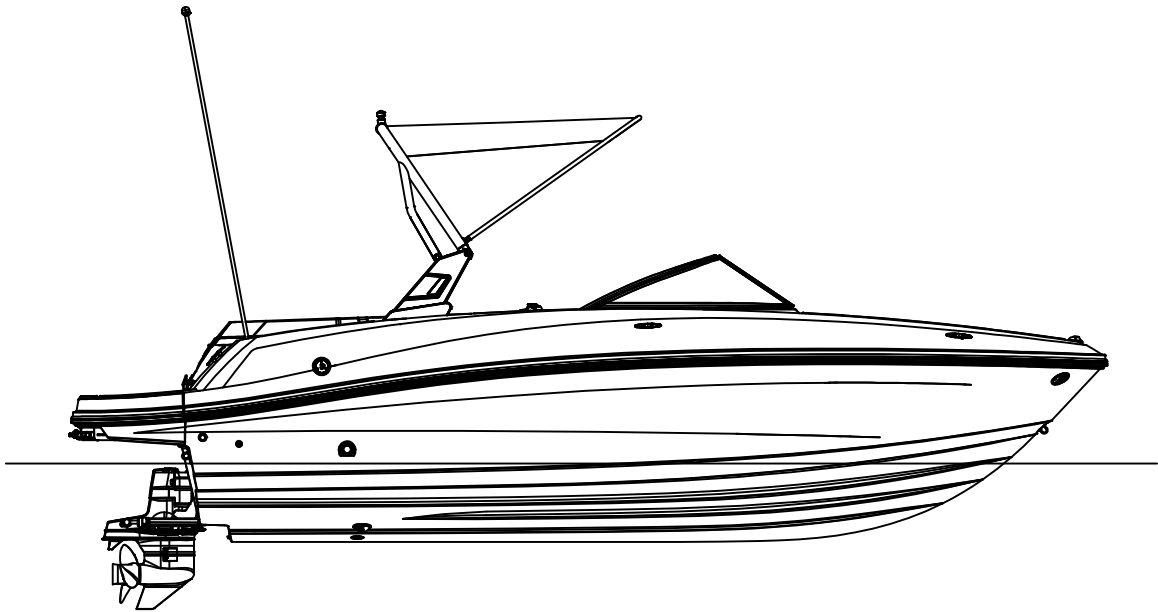

Owner's Manual *Supplement*



**Engine Serial Number:** \_\_\_\_\_

**Hull Identification Number:** \_\_\_\_\_

## Hull Identification Number

- The Hull Identification Number (HIN) is located just below the deck gunnel at the starboard aft corner of the boat.
- Record the HIN (and the engine serial number) in the space provided above.
- Include the HIN with any correspondence or orders.

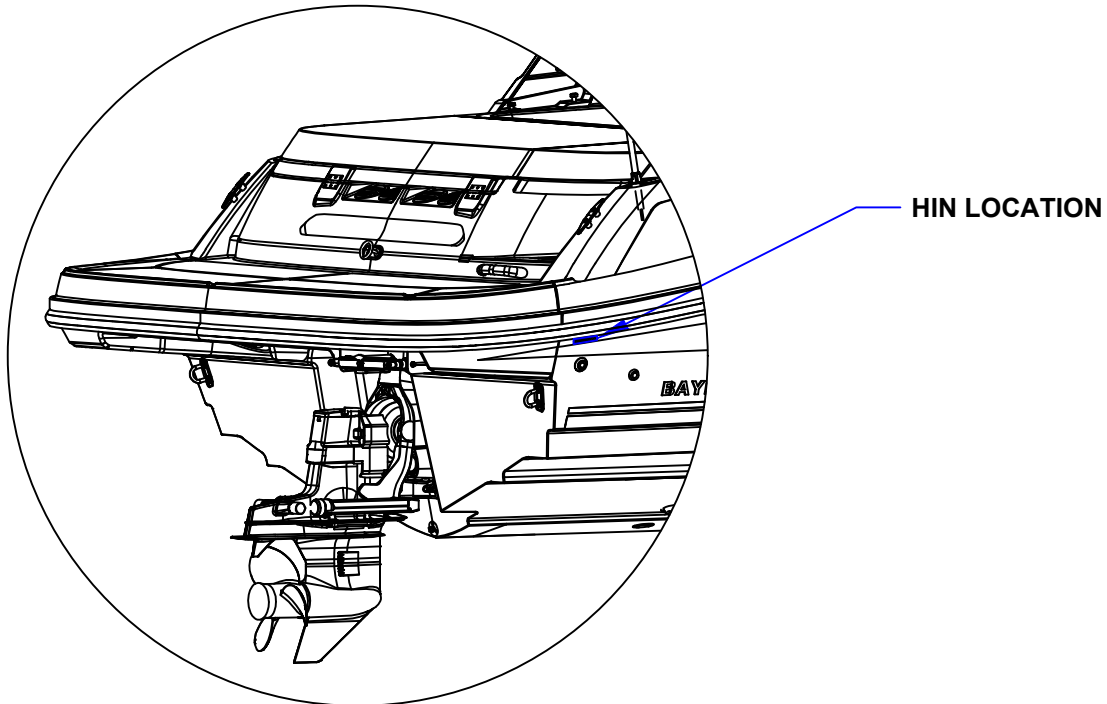

© 2018 Bayliner Technical Publications. All rights reserved.

No part of this publication may be reproduced, stored in any retrieval system, or transmitted in any form by any means, electronic, mechanical, photocopying, recording or otherwise, without prior written permission of Bayliner.

Printed in the United States of America.

### General Notes

The material in this document is for information only and is subject to change without notice. While reasonable efforts have been made in the preparation of this document to assure its accuracy, Bayliner assumes no liability resulting from errors or omissions in this document, or from the use of information contained herein. Due to our commitment to product improvement, Bayliner reserves the right to make changes in the product design, specifications, and equipment at any time without notice or obligation. Illustrations and/or photos may show optional equipment.

All Bayliner products meet or exceed USCG (United States Coast Guard) and/or NMMA (National Marine Manufacturer's Association) construction standards. Manufactured with 1,1,1 Trichloroethane, a substance which harms public health and environment during the manufacturing process by destroying ozone in the upper atmosphere.

### Proprietary Rights

This document discloses subject matter in which Bayliner has proprietary rights. The information and design disclosed herein were originated by and are the property of Bayliner. Neither receipt nor possession thereof confers or transfers any right to reproduce, copy, alter or disclose the document or any part thereof, any information contained therein, or to construct boats or any item from it, except by written permission from or written agreement with Bayliner. This document is to be returned upon request to Bayliner.

Manual Part Number:  
2228253

# CONTENTS

---

<b>Chapter 1: Welcome Aboard!</b>	<b>1</b>
Dealer Service	1
Warranty Information	1
Boating Experience	1
Engine, Accessory Guidelines and Literature	3
Qualified Maintenance	4
Special Care for Moored Boats	4
Safety Standards	5
Carbon Monoxide (CO)	6
<i>CO Facts</i>	6
<i>Factors that Increase the Effects of CO Poisoning</i>	6
<i>Where and How CO Can Accumulate</i>	7
<i>How to Protect Yourself and Others From CO</i>	7
<i>CO Checklists</i>	8
<i>More Information</i>	8
<b>Chapter 2: Locations</b>	<b>9</b>
Dimensions and Specifications	9
Stability	10
Deck Occupation Areas	11
Load Capacity	12
Passenger Locations	13
Watercraft Design Category	14
Warning Labels	15
Helm Warning Labels	16
Exterior Views	17
<i>Hull Views</i>	17
<i>Deck View</i>	18
<i>Helm View</i>	19
Swivel Seat	20
<i>Bilge Components</i>	20
<i>Livewell Components</i>	20
<b>Chapter 3: Propulsion and Related Systems</b>	<b>21</b>
Engine	21
Emergency Cut-off devices	21
Gasoline Fuel System	22
Fuel Tank and Fuel Fill	23
Bilge Blower System	24
Quick Oil Drain System	26
<b>Chapter 4: Controls and Gauges</b>	<b>27</b>
Steering	27
Shift/Throttle Controls	27
Power Trim and Tilt	27
Gauges	27

<b>Chapter 5: Navigation Equipment</b>	<b>28</b>
Depth Finder (If Equipped)	28
<b>Chapter 6: Plumbing</b>	<b>29</b>
Bilge Pump	29
<i>Bilge Pump Testing</i>	30
Drain Systems	30
<i>Deck Drains</i>	30
<b>Chapter 7: Deck Equipment</b>	<b>31</b>
Cleats and Bow/Stern Eyes	31
Ski-Tow Ring	32
Ski-Tow Tower (If Equipped)	32
Canvas	33
<i>Canvas Care</i>	34
<b>Chapter 8: Entertainment System</b>	<b>35</b>
Audio Equipment	35
Automatic Fire Extinguisher System	35
<b>Chapter 9: Lights</b>	<b>36</b>
Care and Maintenance	36
Interior and Exterior Lights	36
Navigation Lights	36
<b>Chapter 10: Electrical System</b>	<b>39</b>
12-Volt DC System	40
<i>Battery</i>	40
<i>Fuses</i>	40
<i>12-Volt DC Accessory Outlet</i>	40
<i>Alternator</i>	40
<i>DC Wiring Schematics (1 of 2)</i>	41
<i>DC Wiring Schematics (2 of 2)</i>	42
Electrical Routings	43
<i>12-Volt DC Deck Harnesses</i>	43
<i>Battery Cable Routings</i>	44
<i>12-Volt DC Hull Harness</i>	45

## Hazard Boxes & Symbols

The hazard boxes and symbols shown below are used throughout this supplement to call attention to potentially dangerous situations which could lead to either personal injury or product damage. Read ***all*** warnings carefully and follow ***all*** safety instructions.

### **DANGER**

**DANGER** - Immediate hazards which **WILL** result in severe personal injury or death if the warning is ignored

### **WARNING**

**WARNING** - Hazards or unsafe practices which **MAY** result in severe personal injury or death if the warning is ignored.

### **CAUTION**

**CAUTION** - Hazards or unsafe practices which **COULD** result in minor injury, product or property damage if the warning is ignored.

### **NOTICE**

Information which is important to proper operation or maintenance, but is not hazard related.

# Chapter 1: Welcome Aboard!

---

This *Owner's Manual Supplement* provides specific information about your boat that is not covered in the *Sport Boat Owner's Manual*.

- The *Sport Boat Owner's Manual* contains general information about safe operating practices, general boating regulations, and general maintenance techniques.
- Before using your boat, study this *Owner's Manual Supplement*, the *Sport Boat Owner's Manual*, and all engine and accessory literature carefully. If similar instructions are found in more than one manual, always refer to the specific manufacturer's manual (such as the engine manual) for the most complete and accurate information.
- Keep this *Owner's Manual Supplement* and the *Sport Boat Owner's Manual* on your boat in a secure, yet readily available place.

## Dealer Service

Your dealer is your key to service.

- Ask your dealer to explain all systems before taking delivery of your boat.
- Contact your dealer if you have any problems with your new boat.
- If your dealer cannot help, call our customer service hotline: 865-971-6311.
- Bayliner advises that all rigging, installation and prep work on any Bayliner product be done by an authorized dealer at the authorized dealer's location.
- Buy replacement parts from any authorized Bayliner dealer.
- You can access additional information by logging on to <http://www.bayliner.com>.

## Warranty Information

- Bayliner offers a Limited Warranty on each new Bayliner purchased through an authorized Bayliner dealer.
- A copy of the Limited Warranty was included in your owner's packet.
- If you did not get a copy of the Limited Warranty, please contact your Bayliner dealer or call 865-971-6311 for a copy.

## Boating Experience

 **WARNING**

**CONTROL HAZARD!**

An experienced operator **MUST** be in control of your boat at ALL times.  
Do NOT operate your boat while under the influence of alcohol or drugs.

If this is your first boat or if you are changing to a type of boat you are not familiar with, for your own comfort and safety, get handling and operating experience before assuming command of your boat. Take one of the boating safety classes offered by the United States Power Squadrons® or the United States Coast Guard Auxiliary. For more course information, including dates and locations of upcoming classes, contact the organizations directly:

- U.S. Power Squadrons: 1-888-FOR-USPS (1-888-367-8777) or [www.usps.org](http://www.usps.org)
- U.S. Coast Guard Auxiliary: 1-800-368-5647 or [www.cgaux.org](http://www.cgaux.org)
- In Canada, for CPS courses: 1-888-CPS-BOAT

Outside the United States, your selling dealer, national sailing federation, or local boat club can advise you of local sea schools or competent instructors.

## Manufacturer's Certification

As a boat manufacturer, Bayliner builds their products to guidelines established under the Federal Boat Safety Act of 1971. The Act is promulgated by the United States Coast Guard who has authority to enforce these laws on boat manufacturers that sell products in the United States. Bayliner ensures that all of its products comply with these laws.

The National Marine Manufacturers Association (NMMA) provides Bayliner with a third party certification. The NMMA is an organization that represents the marine industry and assists manufacturers, boat dealers, marinas, repair yards and component suppliers in areas of legislation, environmental concerns, marine business growth and state and federal government agency interaction. The third party certification that Bayliner participates in, uses the well known Standards and Recommended Practices of the American Boat and Yacht Council (ABYC). Bayliner Boats participates extensively in the American Boat and Yacht Council which is a nonprofit organization that develops and publishes voluntary standards and recommended practices for boat and equipment design, construction, service and repair. We utilize all applicable ABYC standards in the construction of your Bayliner boat.

Finally, Bayliner sells their products world wide and as such must conform to the various rules and regulations required by other countries. Most notably, are the ISO standards in Europe which require the application of the Common European (CE) mark. This mark, much like the NMMA certification here in the US, gives you the boat owner specific information concerning your craft.

## International Requirements

Depending on your boat's original destination, the vessel and its systems may have been constructed in accordance with standards and specifications published by various international authorities such as:

- Construction Standards for Small Vessels - Canada
- Recreational Craft Directive and applicable ISO Standards - European Union
- AS/NZ 3004 Electrical Installations - Australia/New Zealand

Further information concerning these requirements may be obtained from your local dealer.



## Engine & Accessory Guidelines & Literature

### NOTICE

- Before starting or working on your engine(s), read the engine manual.
- Before using the accessories on your boat, read the accessory manuals.
- Before storing your boat, refer to your engine and accessory manuals for storage/winterization instructions.

### NOTICE

Certain modifications to your boat will result in cancellation of your warranty protection. Always check with your dealer before making any modifications.

- Your boat's engine and accessories were selected to provide optimum performance and service.
- Installing a different engine or adding accessories may affect your boat's running trim.
- If you choose to install a different engine or add accessories that may affect your boat's running trim, have a trained marine technician perform a safety inspection and handling test *before* using your boat again.
- The engine and accessories on your boat have their own manuals. Read these manuals *before* using the engine and accessories.

Unless noted otherwise, *all* engine and accessory literature referred to in this *supplement* is included in your owner's packet.

While the topics listed below may be included in this *supplement* and in the *Cruiser & Yacht Owner's Manual*, *always* refer to the engine manual first for specific information on these important subjects:

- Engine Break-in Procedure
- Engine Starting and Stopping
- Gear Shifting

### Propeller



### CAUTION

#### ENGINE DAMAGE HAZARD!

The factory standard propeller may not be the best for your particular boat and load conditions. Refer to the engine manual RPM ratings. The engine should reach, but not exceed its full rated RPM when full-throttle is applied. Immediately contact your local Bayliner dealer if:

- The engine cannot reach its full rated RPM when full-throttle is applied
- The engine exceeds its full rated RPM when full-throttle is applied

- Keep the propeller in good repair and at the correct pitch for your particular situation.
- A slightly bent or nicked propeller will adversely affect the performance of your boat.

## Qualified Maintenance

### WARNING

To maintain the safety of your boat, allow **ONLY** trained personnel to work on, or change, in any way, the following:

- Steering system
- Propulsion system
- Engine control system
- Fuel system
- Environmental control system
- Electrical system
- Navigation system

Failure to maintain your boat's systems (listed in the warning above) as designed could violate the laws in your jurisdiction and could expose yourself and others to the danger of bodily injury or accidental death.

Follow the maintenance instructions in:

- This *Owner's Manual Supplement*
- The *Cruiser & Yacht Owner's Manual*
- The engine owner's manual, and;
- **All** accessory literature.

## Special Care for Moored Boats

### NOTICE

- To help seal the hull bottom and reduce the chance of gel coat blistering while your boat is moored, apply an epoxy barrier coating.
- The barrier coating should be covered with several coats of anti-fouling paint.
- Many states regulate the chemical content of bottom paints in order to meet environmental standards. Check with your local dealer about recommended bottom paints, and about the laws in effect in your area.

- Whether moored in saltwater or freshwater, your boat will collect marine growth on its hull bottom.
- This will detract from your boat's beauty, greatly affect its performance, and may damage the gel coat.
- Periodically haul your boat out of the water and scrub the hull bottom with a bristle brush and a solution of soap and water.

## Safety Standards

### **DANGER**

#### **FALLING and ROTATING PROPELLER HAZARD!**

- NEVER allow anyone to ride on parts of your boat not designed for such use.
- Sitting on seat-backs, lounging on the forward deck, bow riding, gunwale riding or occupying the transom platform while underway is especially hazardous and WILL cause personal injury or death.

### **DANGER**

#### **FALLING, ROTATING PROPELLER and CARBON MONOXIDE POISONING HAZARD!**

- NEVER allow anyone to occupy, or hang from, the back deck or transom platform while the engine is running.
- Teak surfing, dragging, or water skiing within 20 feet of a moving watercraft can be fatal.

### **DANGER**

#### **PERSONAL SAFETY HAZARD!**

- ALWAYS secure the anchor and other loose objects BEFORE getting underway.
- The anchor and other items that are not properly secured can come loose when your boat is moving and cause personal injury or death.

### **WARNING**

A wide variety of components used on this vessel contain or emit chemicals known to the State of California to cause cancer and birth defects and other reproductive harm. Examples include:

- Engine and generator exhaust
  - Engine and generator fuel, and other liquids such as coolants and oil, especially used motor oil
  - Cooking fuels
  - Cleaners, paints, and substances used for vessel repair
  - Waste materials that result from wear of vessel components
  - Lead from battery terminals and other sources such as ballast or fishing sinkers
- To Avoid Harm:
- Keep away from engine, generator, and cooking fuel exhaust fumes.
  - Wash exposed skin thoroughly with soap and water after handling the substances above.

- Your boat's mechanical and electrical systems were designed to meet safety standards in effect at the time it was built.
- Some of these standards were mandated by law, and all of them were designed to insure your safety and the safety of other people, vessels and property.

Read this supplement, the *Sport Boat Owner's Manual*, the engine owner's manual, and **all** accessory instructions for important safety standards and hazard information.

## Carbon Monoxide (CO)

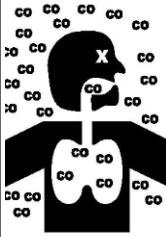
 <b>WARNING</b>	
	<p>Carbon monoxide (CO) can cause brain damage or death.</p> <p>Engine and generator exhaust contains odorless and colorless carbon monoxide gas.</p> <p>Signs of carbon monoxide poisoning include nausea, headache, dizziness, drowsiness, and lack of consciousness.</p> <p>Get fresh air if anyone shows signs of carbon monoxide poisoning.</p> <p>See Owner's Manual for information regarding carbon monoxide poisoning.</p>

### **CO Facts**

- CO poisoning causes a significant number of boating deaths each year.
- Called the "silent killer", CO is an extremely toxic, colorless, odorless and tasteless gas.
- CO can harm or even kill you inside or outside your boat.
- CO can affect you whether you're underway, moored, or anchored.
- CO symptoms are similar to seasickness or alcohol intoxication.
- CO can make you sick in seconds. In high enough concentrations, even a few breaths can be fatal.
- Breathing CO blocks the ability of your blood to carry oxygen.
- The effects are cumulative. Even low levels of exposure can result in injury or death.

### **Factors that Increase the Effects of CO Poisoning**

- Age
- Smokers or people exposed to high concentrations of cigarette smoke
- Consumption of alcohol
- Lung disorders
- Heart problems
- Pregnancy

## Where & How CO Can Accumulate

### Stationary conditions that increase CO accumulations include:

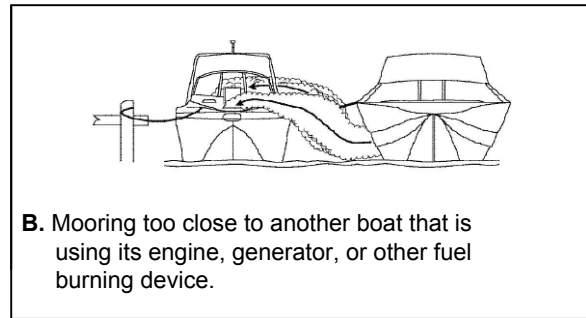
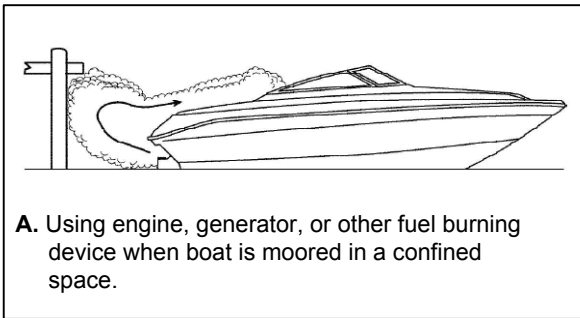

### To correct stationary situations A and/or B:

- **Close all** windows, portlights and hatches.
- If possible, move your boat away from source of CO.

### Running conditions that increase CO accumulations include:

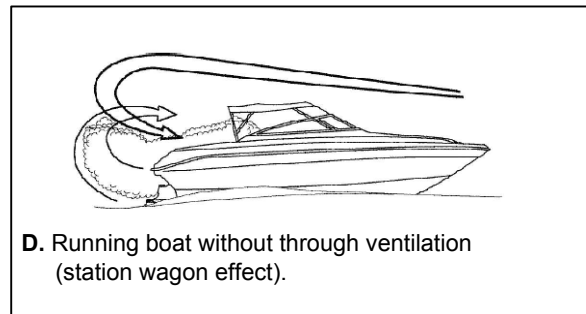
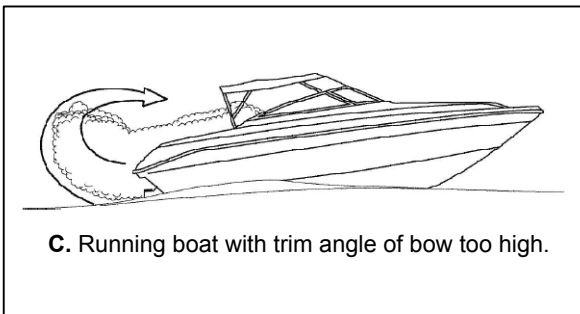

### To correct running situations C and/or D:

- Trim bow down.
- Open windows and canvas.
- When possible, run boat so that prevailing winds help dissipate exhaust.

## How to Protect Yourself & Others From CO

- Know where and how CO may accumulate in and around your boat (see above).
- **Always** maintain fresh air circulation throughout your boat.
- Know where your engine and generator exhaust outlets are located and keep everyone away from these areas.
- **Never** sit on, or hang onto, the back deck or transom platform while the engine is running.
- **Never** enter the areas under transom platforms where exhaust outlets are located.
- Although CO can be present without the smell of exhaust fumes, if exhaust fumes are detected on your boat, take **immediate** action to dissipate these fumes.
- Treat symptoms of seasickness as possible CO poisoning. Get the person into fresh air **immediately**. Seek medical attention—unless you're sure it's **not** CO.
- **Maintain the CO monitors that are installed inside your boat.** Never ignore any alarm. Replace monitors as recommended by the monitor manufacturer.
- Follow the checklists provided on the next page.
- Get a Vessel Safety Check.

For information on how to get a free VESSEL SAFETY CHECK, visit [www.vesselsafetycheck.org](http://www.vesselsafetycheck.org) or contact your local U.S. Coast Guard Auxiliary or United States Power Squadrons®.

- U.S. Coast Guard Auxiliary: 1-800-368-5647 or on the Internet at: <http://www.cgaux.org>
- U.S. Power Squadrons: 1-888-FOR-USPS (1-888-367-8777) or on the Internet at: <http://www.usps.org>

## CO Checklists

### Trip Checklist

- Make sure you know where the exhaust outlets are located on your boat.
- Educate *all* passengers about the symptoms of CO poisoning and where CO may accumulate.
- When docked, or rafted with another boat, be aware of exhaust emissions from the other boat.
- Listen for any change in exhaust sound, which could mean an exhaust component failure.

### Monthly Checklist

- Make sure all exhaust clamps are in place and secure.
- Look for exhaust leaking from exhaust system components. Signs include rust and/or black streaking, water leaks, or corroded or cracked fittings.
- Inspect rubber exhaust hoses for burned, cracked, or deteriorated sections. **All** rubber hoses should be pliable and free of kinks.

### Annual Checklist

#### Have a Trained Marine Technician:

- Replace exhaust hoses if cracking, charring, or deterioration is found.
- Ensure that your engines and generators are properly tuned, and well maintained.
- Inspect each water pump impeller and the water pump housing. Replace if worn. Make sure cooling systems are in working condition.
- Inspect all metallic exhaust components for cracking, rusting, leaking, or loosening. Make sure they check the cylinder head gasket, exhaust manifold, water injection elbow, and the threaded adapter nipple between the manifold and the elbow.
- Clean, inspect, and confirm proper operation of the generator cooling water anti-siphon valve (if equipped).

### More Information

For more information about preventing carbon monoxide poisoning on recreational boats and other boating safety tips, contact:

United States Coast Guard  
Office of Boating Safety (G-OPB-3)  
2100 Second Street SW  
Washington, DC 20593  
[www.uscgboating.org](http://www.uscgboating.org)  
1-800-368-5647

National Marine Manufacturers  
Association (NMMA)  
200 East Randolph Drive  
Suite 5100  
Chicago, IL 60601-9301  
[www.nmma.org](http://www.nmma.org)  
312-946-6200

American Boat & Yacht Council,  
Inc. (ABYC)  
613 Third Street  
Suite 10  
Annapolis, MD 21403  
[www.abycinc.org](http://www.abycinc.org)  
410-990-4460

# Chapter 2: Locations

## Dimensions and Specifications

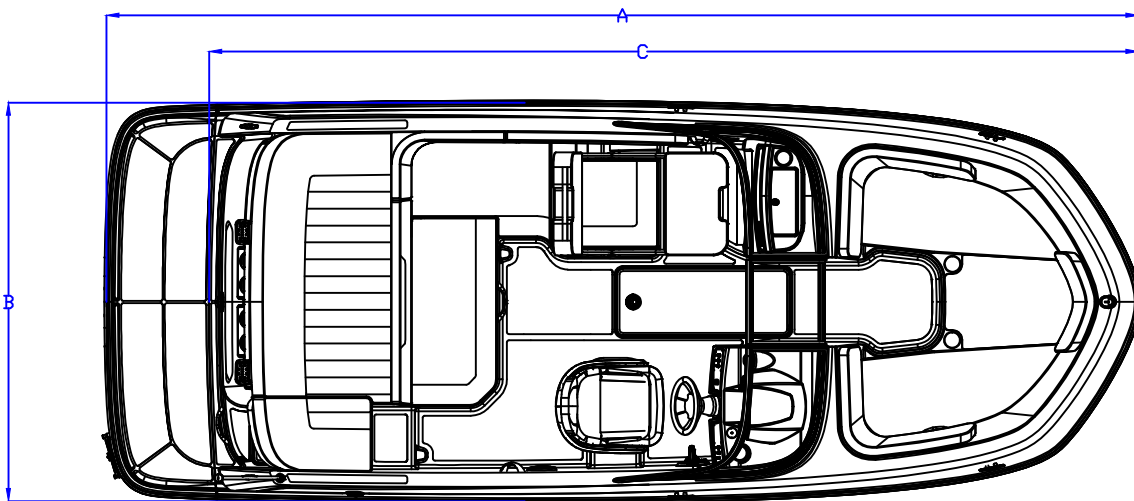
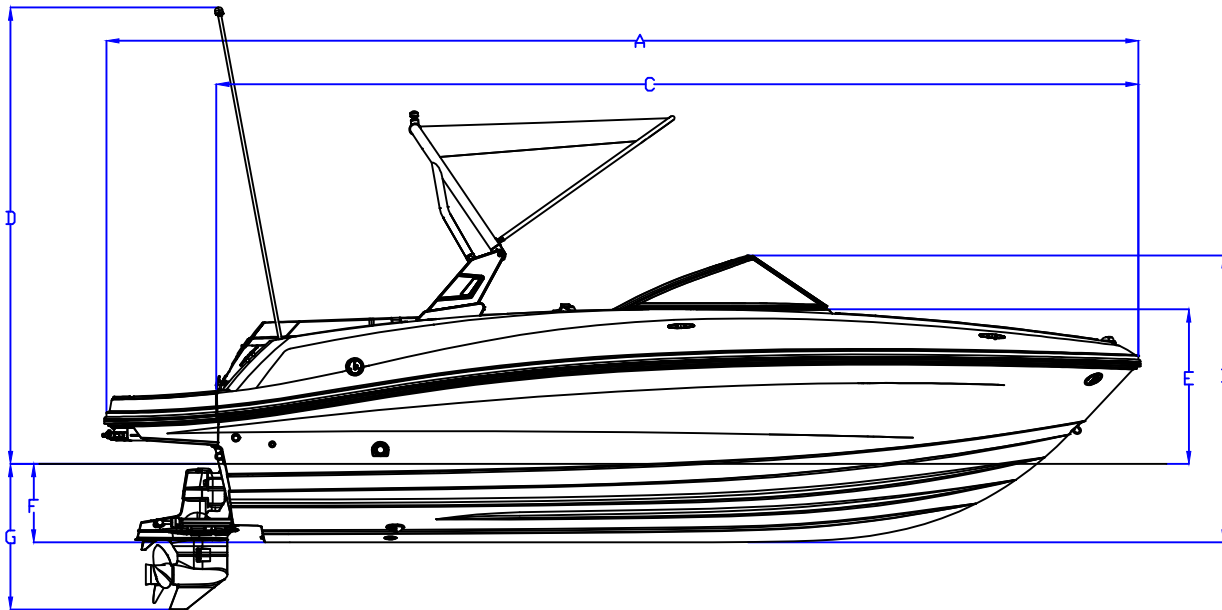

**VR5 Specifications:**

(A) Length Overall	20,40'	6.23 m
(B) Beam	7' 87"	2.40 m
(C) Length of Hull	18,31"	5.58 m
(D) Bridge Clearance	9' 02"	2.75 m
(E) Height From LWL	4' 13"	1.26 m
(F) Draft (Hull)	1'55"	0.47 m
(G) Draft (Maximum)	2' 87"	0.88 m
(I) Overall Height	11' 99"	3.63 m
Fuel Capacity	33 gallons	124.92 liters
Dry Weight	3307 lbs	1500.00 kg
Dead Rise	20°	

**Stability****! WARNING**

Wet decks are slippery.  
 You can be seriously injured if you slip and fall.  
 Wear slip resistant footwear secured to your feet and hold on to rails or boat structure.

**! WARNING**

Boat motion can be erratic.  
 You can fall overboard or be injured by hitting something in or on the boat.  
 All persons must be in cockpit area or cabin and be prepared for sudden boat movement.  
 Use front or bow deck area only during anchoring, mooring or emergencies

When persons are on the working deck area, for anchoring, mooring, or in emergencies, they must be holding on and be positioned so as to prevent falling. In bad weather and/or rough water, if it is essential to be on deck, persons should be closely tied to cleats, railing stanchions or other securely fastened boat hardware. Your boat was manufactured to specific stability and flotation standards for the capacity shown on the certification plate. Any increase from the recommended load capacities will put your boat in jeopardy of capsizing, swamping and/or sinking.

In Addition:

- Stability may be substantially reduced if equipment is added above the deck.
- Stability is substantially reduced by loose fluids or weight within the hull. Keep bilge area as dry as possible, and close all openings, hatches and windows in rough weather.

**! DANGER**



Rotating propellers can injure or kill you.  
 Shut off engine when persons are in water near boat, or on swim platform or ladder.

**! WARNING**

Distribute passengers and gear as uniformly as possible from front to rear and left to right.  
 The manufacturer's load rating is the maximum allowed under calm conditions.  
 Reduce boat loading if weather, water or other conditions are adverse.



### Deck Occupation Areas

-  **WORKING DECK**  
(DECK AREA INTENDED FOR OCCUPATION DURING NORMAL OPERATION)
  
-  DECK AREA INTENDED FOR USE ONLY IF BOAT IS ANCHORING OR MOORING OR IN EMERGENCY SITUATION ONLY.

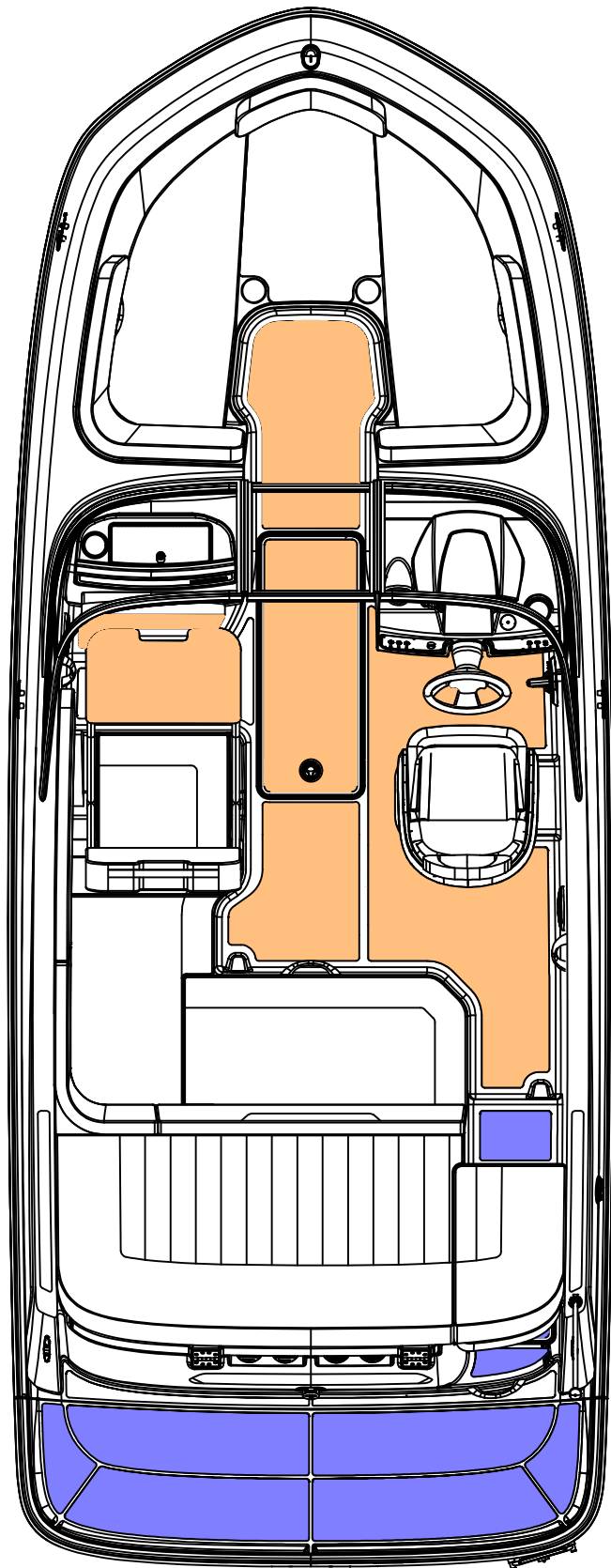

**Load Capacity**

**WARNING**

Never carry more weight or passengers than indicated on the certification plate, regardless of weather or water conditions.  
The boat can capsize, swamp or sink.

If present, the capacity information plate (located near the helm) indicates maximum weight and number of persons your boat can handle under calm sea conditions. Do not exceed the load capacities stated. The number of people on board must be reduced if you go out in poor weather and rough water.

The type of capacity plate will vary dependant upon the local governing authority.

- A. United States - The United States Coast Guard only provides specific numbers for passenger capacity or cargo weight for recreational vessels up to 20', (6.1 meters). NMMA provides capacity for boats under 26' (7.9 meters).
- B. Canada - Transport Canada only provides specific numbers for passenger capacity or cargo weight for recreational vessels up to 6 meters (19.7').
- C. Australia - The Australian Transport Council provides specific numbers for passenger capacity and cargo weight for all recreational vessels.
- D. European Union - CE regulations provide specific information for passenger capacity and cargo weight for all recreational vessels.

**Capacity Plate (Domestic Certification)**

MAXIMUM NUMBER OF PASSENGERS

MAXIMUM LOAD CAPACITY

**Capacity Plate (International Certification)**

BOAT MANUFACTURER

MAXIMUM LOAD CAPACITY

DESIGN CATEGORY

MAXIMUM NUMBER OF PASSENGERS

### Passenger Locations

## NOTICE

The maximum number of persons listed on the capacity plate may be affected by where the vessel is registered. See Load Capacity.

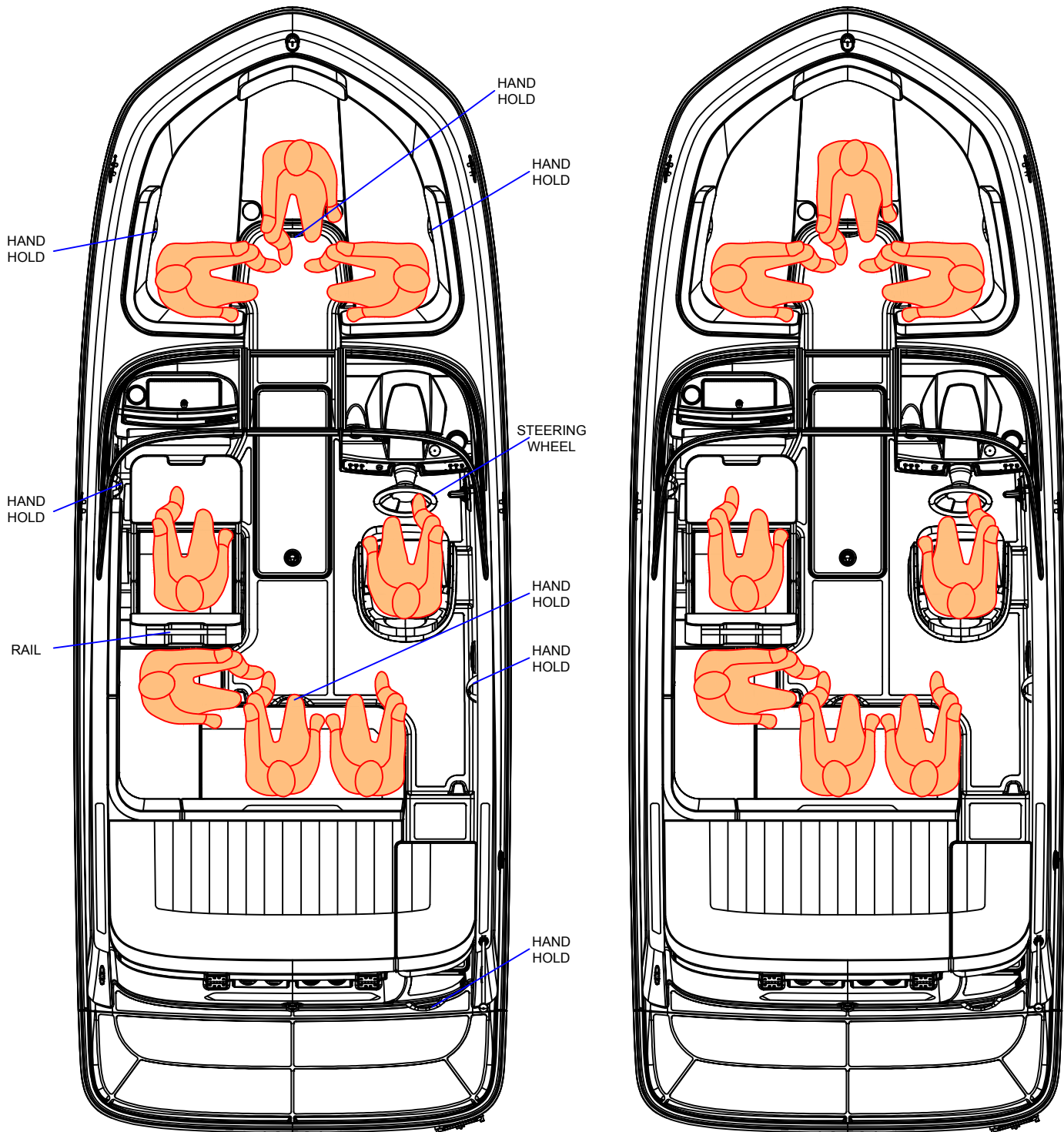

**DOMESTIC**

**INTERNACIONAL, (CE)**

### **Watercraft Design Category**

A watercraft given design category C is considered to be designed for a wind force up to, and including 6 (Beaufort scale) and significant wave height up to, and including 2 m.



The wind speed and wave height specified as the upper limit for your category of boat does not mean that you or your passengers can survive if your boat is exposed to these conditions. It is only the most experienced operators and crew that may be able to operate a boat safely under these conditions.

You must always be aware of weather conditions and head for port or protected waters in sufficient time to avoid being caught in high winds and rough water. Do not take chances!

### **Maximum Propulsion Power**

- “Maximum propulsion power rating for the craft: 164kW.”
- “Do not operate this craft with an engine of rated power larger than that posted on the capacity label in the craft.”
- “Do not operate this craft at negative propulsion unit trim settings (bow down) at high speed. Craft may lean over on side. Instability in turns may result. Use negative trim to accelerate to planing speed from displacement speed and at lower planing speeds in choppy water (applicable to craft equipped with propulsion unit power trim).”
- “Do not operate at maximum speed while in congested high traffic waterways or in weather and sea conditions of reduced visibility, high winds or large waves. Reduce speed and wake as a courtesy and as a safety consideration to yourself and others. Observe and obey speed limit and no wake zones.”
- “Observe right-of-way as defined by Rules of the Road and required by COLREG.”
- “Always be certain to have sufficient distance to stop or manoeuvre if required to avoid collisions.”

Warning Labels

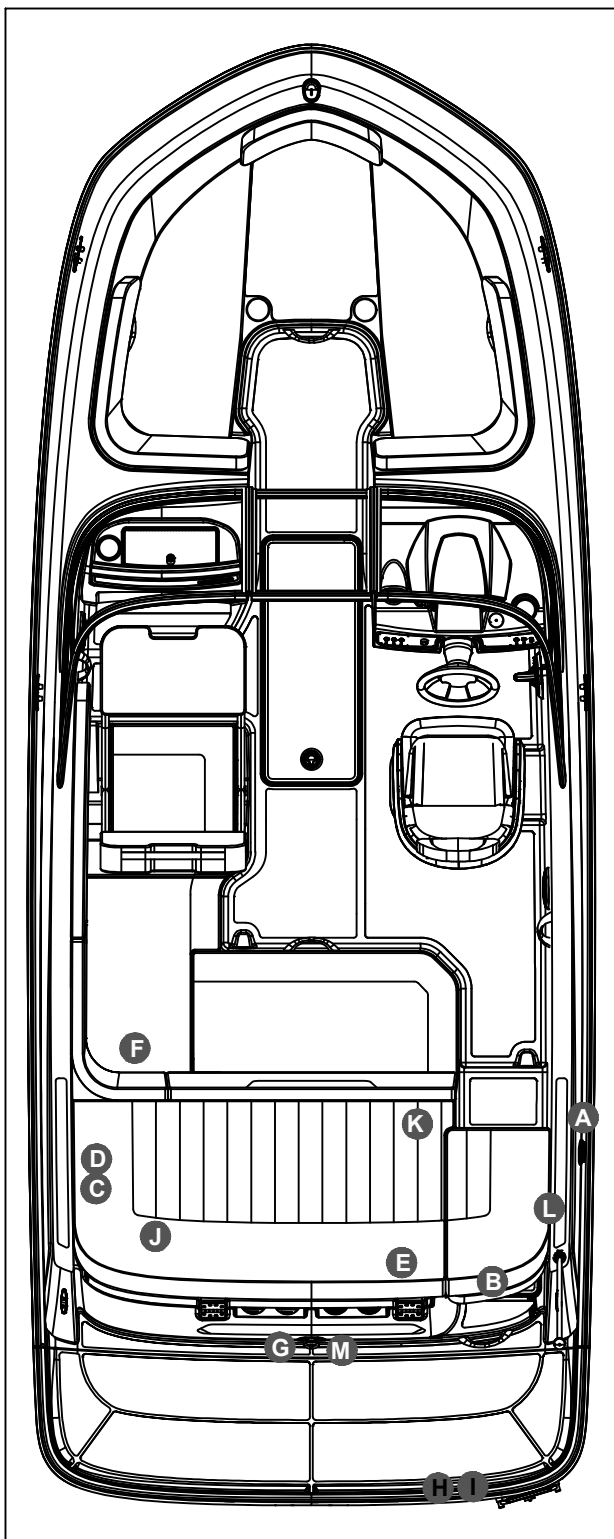

**A** **! WARNING**

Gasoline vapors are explosive! Avoid serious injury or death from fire or explosion, resulting from leaking fuel. Inspect system for leaks at least once a year.

Contents can be under pressure. Open slowly in a well ventilated area.

The use of fuels containing ethanol higher than 10% (E-10) can damage your engine or fuel system and will void the warranty. Never use (E-85).

Open flame appliances can ignite gasoline vapors causing death or injuries from the fire or explosion. Turn off all open flame appliances when refueling.

**B** **! DANGER**

TO AVOID RISK OF SERIOUS INJURY SUN PAD MUST BE IN DOWN POSITION WHEN ENGINE IS RUNNING

**C** **! WARNING**

LEAKING FUEL IS A FIRE AND EXPLOSION HAZARD. INSPECT SYSTEM REGULARLY. EXAMINE FUEL TANKS FOR LEAKS OR CORROSION AT LEAST ANNUALLY.

**D** **NOTICE**

FIXED FIRE EXTINGUISHING SYSTEM MUST BE SUITABLE FOR COMPARTMENT VOLUME OF 100 cu. ft.

**E** **! DANGER**

STAY CLEAR OF MOVING PARTS WHILE ENGINE IS RUNNING.

**F** **! CAUTION**

IF SWITCH IS TURNED OFF WHILE ENGINE IS RUNNING ALTERNATOR WILL BE DAMAGED.

**G** **! WARNING**

USE CAUTION WITH SKIER IN TOW AS TOW ROPE MAY BACKLASH INTO COCKPIT WHEN RELEASED

**H** **! DANGER**

CONTACT WITH A SPINNING PROPELLER WILL CAUSE SERIOUS INJURY OR DEATH. STAY CLEAR OF BOAT AND STAY OFF SWIM PLATFORM AND BOARDING LADDER WHILE ENGINE IS RUNNING

**I** **! DANGER**



Carbon monoxide (CO) can cause brain damage or death. Engine and generator exhaust contains odorless and colorless carbon monoxide gas. Carbon monoxide will be around the back of the boat when engines or generators are running. Move to fresh air, if you feel nausea, headache, dizziness, or drowsiness.

**N** **! WARNING**

FAILURE TO FOLLOW THESE GUIDELINES CAN RESULT IN INJURY OR DEATH.

- DO NOT TOW MORE THAN ONE PERSON AT ONE TIME
- ONLY TOW WATER SKI'S, WAKEBOARDS OR RECREATIONAL TOWABLES, DO NOT USE FOR PARASAILING OR TOWING OTHER BOATS
- DO NOT CLIMB ON, SIT ON, JUMP OFF OR DIVE OFF TOWER
- NEVER ALLOW PASSENGERS TO SIT BEHIND TOW ROPE ATTACHMENT POINT
- USE CAUTION WITH SKIER IN TOW AS TOW ROPE MAY SNAP BACK INTO COCKPIT WHEN RELEASED
- NEVER ALLOW LOOSE TOW ROPE ENDS TO DANGLE FROM TOWER
- ALWAYS BE CERTAIN THAT ALL BOLTS ARE IN PLACE AND TIGHT BEFORE AND DURING USE
- WHEN TOWER OS UP, WATCH FOR LOW OBSTACLES SUCH AS TREE LIMBS, BRIDGES OR POWER LINES.

**J** **PREVENT THE DISCHARGE OF POLLUTANTS**

DISCHARGE OF OIL OR OILY WASTE INTO NAVIGABLE WATERS IS PROHIBITED IF SUCH A DISCHARGE CAUSES A FILM, SHEEN OR A DISCOLORATION OF THE SURFACE, OR CAUSES A SLUDGE OR EMULSION BENEATH THE SURFACE OF THE WATER. VIOLATORS ARE SUBJECT TO PENALTIES.

**K** **NOTICE**

CHECK BATTERY CELL FLUID LEVEL APPROXIMATELY EVERY 4 WEEKS, AND MORE OFTEN IN SUMMER AND HOT ZONES.

**L** **NOTICE**

REMOVE PANEL FOR ACCESS TO FUEL SYSTEM

**M** **! WARNING**

DO NOT EXCEED MAXIMUM TOW WEIGHT OF 400 POUNDS

\*TOWER OPTION

\*TOWER OPTION

## Helm Warning Labels

**A**

U.S. COAST GUARD  
**MAXIMUM CAPACITIES**

**8 PERSONS OR 1323 LBS**  
 1790 LBS. PERSONS, GEAR

THIS BOAT COMPLIES WITH U.S. COAST GUARD SAFETY STANDARDS IN EFFECT ON THE DATE OF CERTIFICATION

MANUFACTURER: BAYLINER MARINE LAKE FOREST, IL  
 MODEL: VR5

DESIGN COMPLIANCE WITH NMMA REQUIREMENTS IS VERIFIED,  
 MANUFACTURER RESPONSIBLE FOR PRODUCTION CONTROL



MEETS U.S. EPA EVAP STANDARDS USING CERTIFIED COMPONENTS

**A**



**BAYLINER MARINE**  
 LAKE FOREST, IL, USA

**MAXIMUM**

**8 + = 857 kg**

**B**

THE UNITED STATES COAST GUARD (USCG) RECOMMENDS THAT ALL OCCUPANTS WEAR APPROVED PERSONAL FLOTATION DEVICES (PFDs).

**! DANGER**

PROPELLER(S) MAY CAUSE SERIOUS INJURY OR DEATH  
 Shut-off engine(s) when near swimmers, prior to using sunpads, swim platform, or boarding ladder.

**! WARNING**

AVOID COLLISIONS-

- Maintain lookout as required by the "Rules of the Road"
- Visibility can be limited by high boat trim angles, persons, gear, weather and atmospheric conditions.
- At all times proceed at a safe speed, in order to take proper and effective action to avoid hazardous conditions.

SUCH ISSUES ARE UNDER THE CONTROL OF THE OPERATOR!  
 AVOID SKI LINES AND TOW ROPES-  
 Ski lines and tow ropes can backlash into the cockpit when released.

**! CAUTION**

AVOID INHALATION OF TOXIC FUMES-  
 If fire extinguishing system discharge occurs, ventilate space before entering.

**C**

**! WARNING**

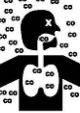

Carbon monoxide (CO) can cause brain damage or death.

Engine and generator exhaust contains odorless and colorless carbon monoxide gas.

Signs of carbon monoxide poisoning include nausea, headache, dizziness, drowsiness, and lack of consciousness.

Get fresh air if anyone shows signs of carbon monoxide poisoning.

See Owner's Manual for information regarding carbon monoxide poisoning.

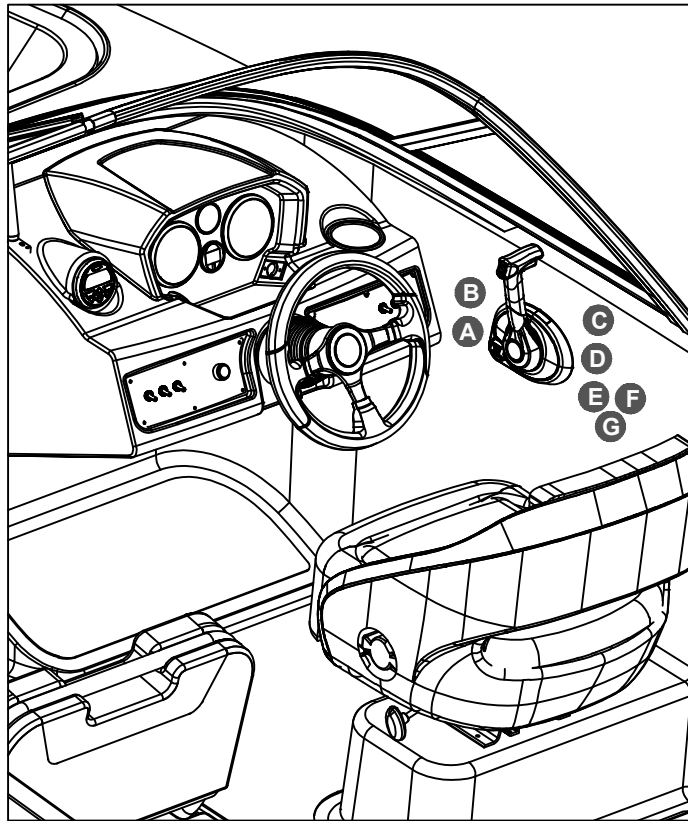

**D**

**! WARNING**

ATTACH SHUT DOWN SWITCH LANYARD TO QUALIFIED OPERATOR WHILE ENGINE IS IN OPERATION. UNCONTROLLED BOAT MAY CAUSE INJURY OR DEATH. READ THE OWNERS MANUAL BEFORE USE.

**E**

**! WARNING**

VISIBILITY FROM THE SEATED POSITION AT THIS HELM STATION IS LIMITED. AVOID SERIOUS INJURY OR DEATH FROM COLLISIONS. OPERATION FROM STANDING POSITION MAY BE NECESSARY TO MAINTAIN LOCKOUT AS REQUIRED BY RULES OF THE ROAD. READ THE OWNERS MANUAL.

**F**

**! WARNING**

QUALIFIED OPERATOR TO BE IN CONTROL AT ALL TIMES. OPERATION BY AN UNQUALIFIED OPERATOR CAN CAUSE LOSS OF CONTROL. THIS MAY RESULT IN SEVERE INJURY, DEATH, OR PROPERTY DAMAGE. BOAT STABILITY AND HANDLING WILL CHANGE WITH WEIGHT DISTRIBUTION. READ OWNERS MANUAL BEFORE USE.

**G**

**! DANGER**

FORE AND AFT SUN PADS SHOULD NOT BE USED WHEN VESSEL IS UNDER WAY.

### Exterior Views

#### Hull Views

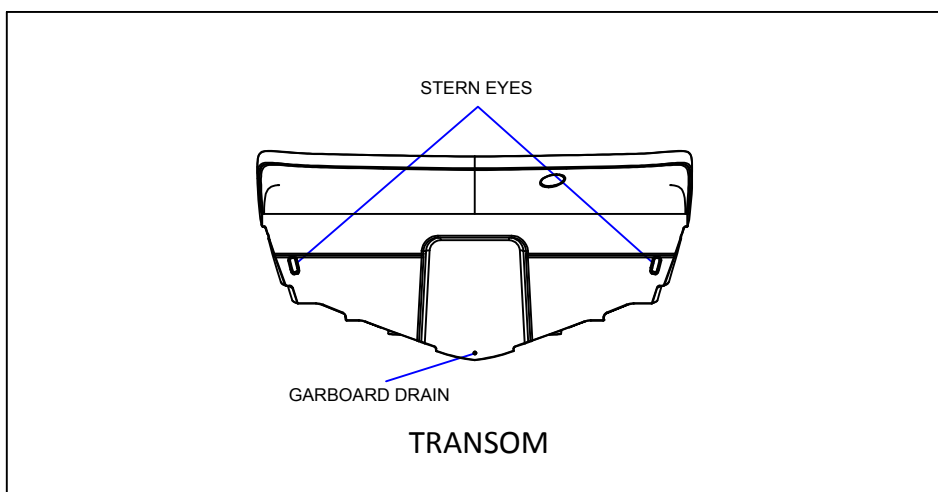
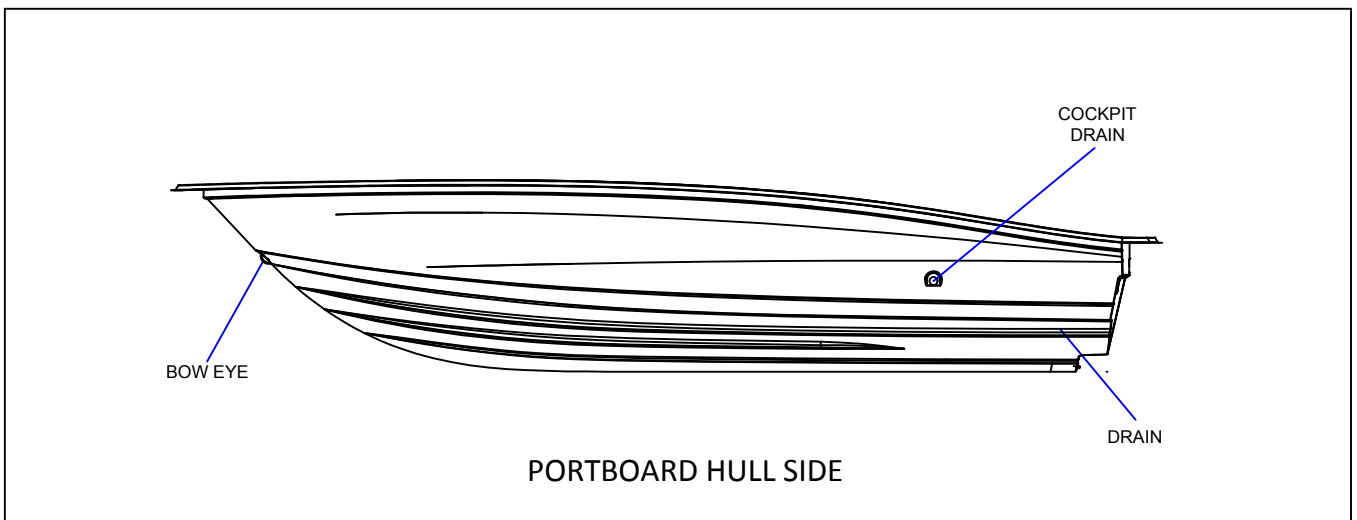
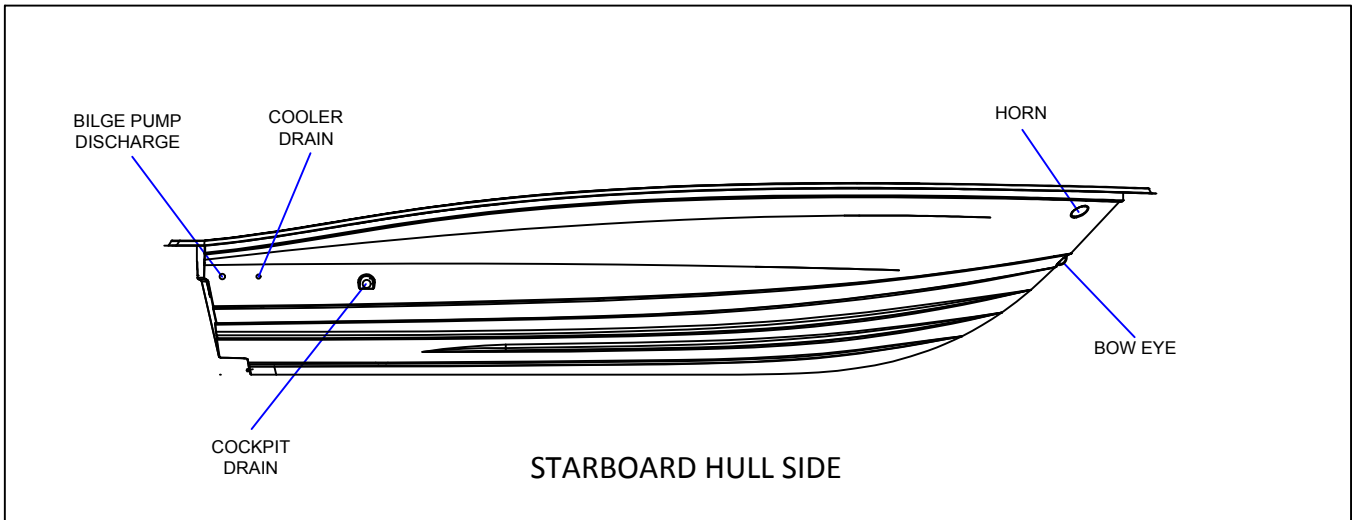

### Deck View

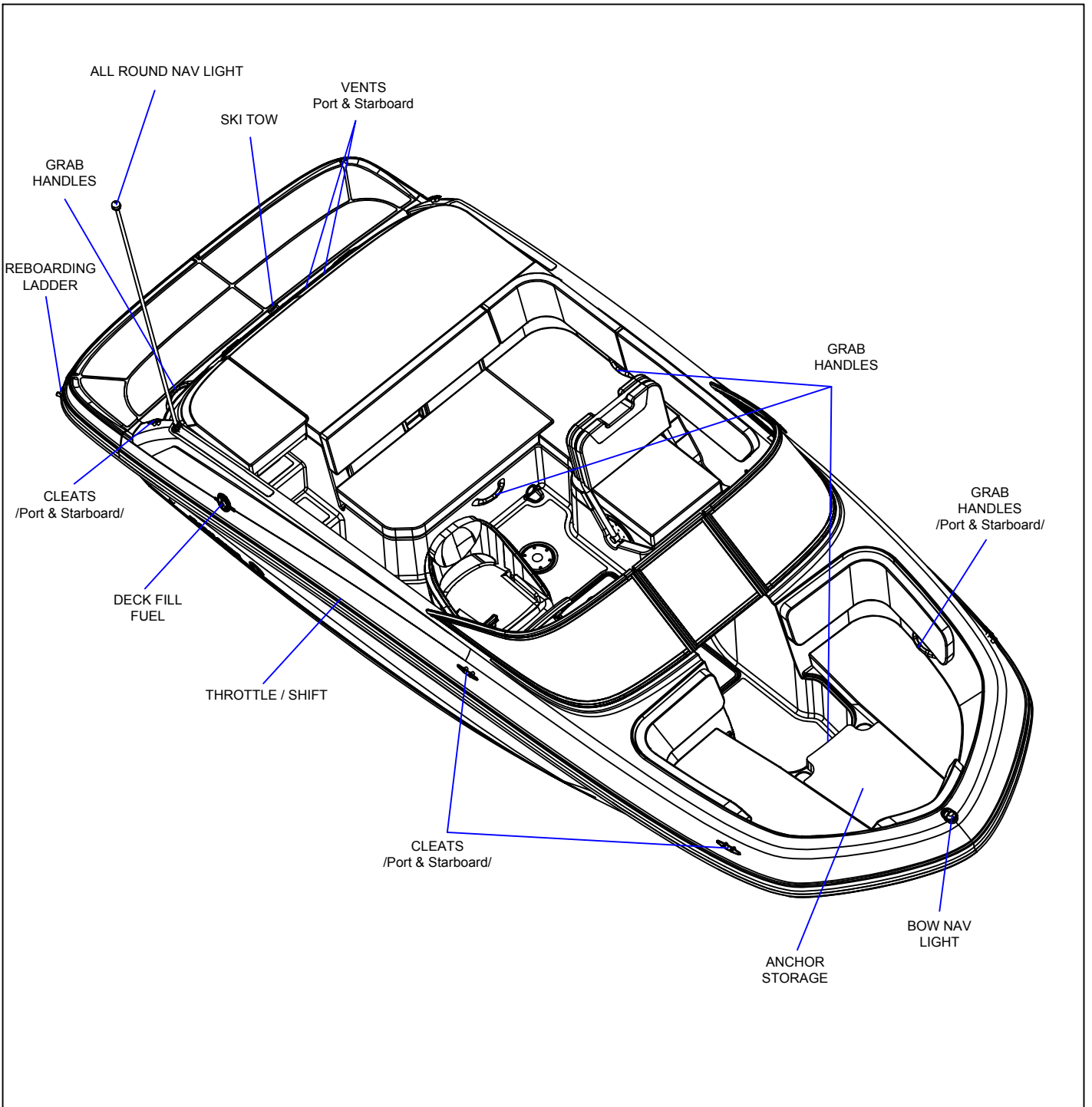

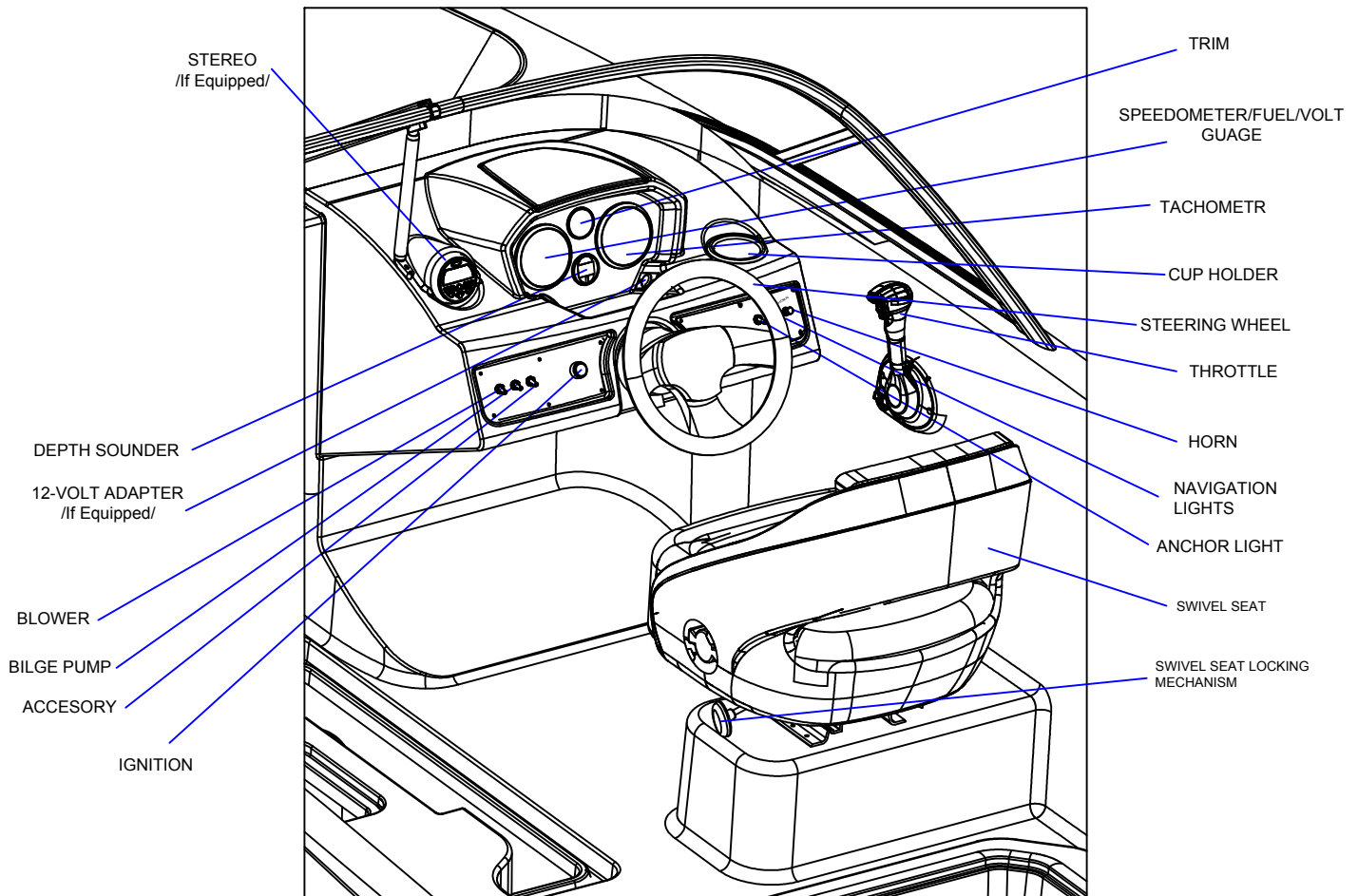

**Helm View**

Operator vision from the helm may be obstructed by high trim angles of the craft and other factors caused by one or more of the following variable conditions:

1. propulsion unit trim angles (on craft equipped with a power trim system on the propulsion unit);
2. hull trim plane angles (on craft equipped with power operated trim planes or trim tabs on the transom);
3. loading and load distribution;
4. speed;
5. rapid acceleration;
6. transition from displacement to planing mode;
7. sea conditions;
8. rain and spray;
9. darkness and fog;
10. interior lights;
11. position of tops and curtains;
12. persons or movable gear in the operator's field of vision.

The International Regulations for Preventing Collisions at Sea (COLREG) and the rules of the road require that a proper lookout be maintained at all times and observance of right of way be respected. Observance of these rules is essential.

## Swivel Seat

Your boat is equipped with manually locked swivel seat. Locking mechanism is localized below swivel seat. Before running the boat check locking mechanism. To avoid serious or fatal injury due to rotation of the seat always lock swivel when boat speed exceeds 5 M.P.H.

### Component Locations Bilge Components

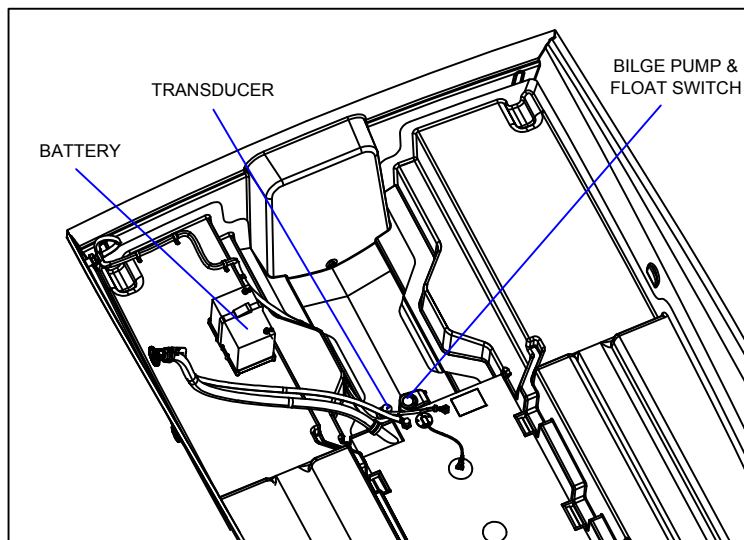

### Livewell Components (Domestic)

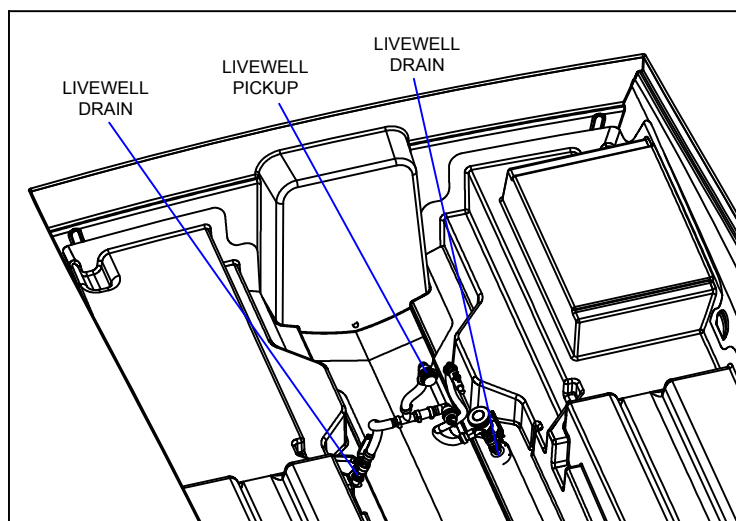

## Chapter 3: Propulsion and Related Systems

---

### Engine

#### NOTICE

Read the engine manual BEFORE starting or working on your engine

While the topics listed below may be included in this supplement and in the *Sport Boat Owner's Manual*, always refer to the engine manual first for specific information on these important subjects:

- Engine Break-in Procedure
- Engine Starting and Stopping
- Gear Shifting
- Fuel and Oil Recommendations
- Engine Maintenance
- Engine Storage/Winterization

### **Emergency Engine Cut-off Devices**

Your boat is equipped with an emergency engine cut-off switch, which is designed to shut engine down if operator is thrown from the proper operating position. The engine cut-off switch works by attaching a lanyard between the operator and the switch. Switch is localized near to the throttle. Engine will shut-off when the lanyard is removed from the switch.

Always make sure the emergency engine shutdown switch cap is in place and the lanyard is attached to the boat operator. A serious accident may occur if the emergency engine shut-off system is not attached correctly. Emergency engine shut-off system activation may cause uncontrolled movement of the boat. Always make sure that all occupants wearing personal flotation devices.

## Gasoline Fuel System

The gasoline fuel system consists of a portable fuel tank, fuel demand valve, and engine fuel supply line. Your vessel contains a new EPA certified fuel system. The system lowers the out gassing emissions through the tank's built-in pressure relief cap.

### ! WARNING

#### FIRE, EXPLOSION, and OPEN FLAME HAZARD!

- Thoroughly inspect the fuel system for leaks every time you take on fuel.
- Follow both the *Sport Boat Owner's Manual* fueling instructions and the engine operation manual fuel recommendations.

### ! WARNING

The fuel tank compartment shall only be used to store the portable fuel tank. Do not store fuel in any other location on the boat. Do not store or handle gear near the fuel lines, fittings or tank.

### NOTICE

Carefully read the fuel section of both the *Sport Boat Owner's Manual* and the engine operation manual, paying special attention to the subject of fuel recommendations.

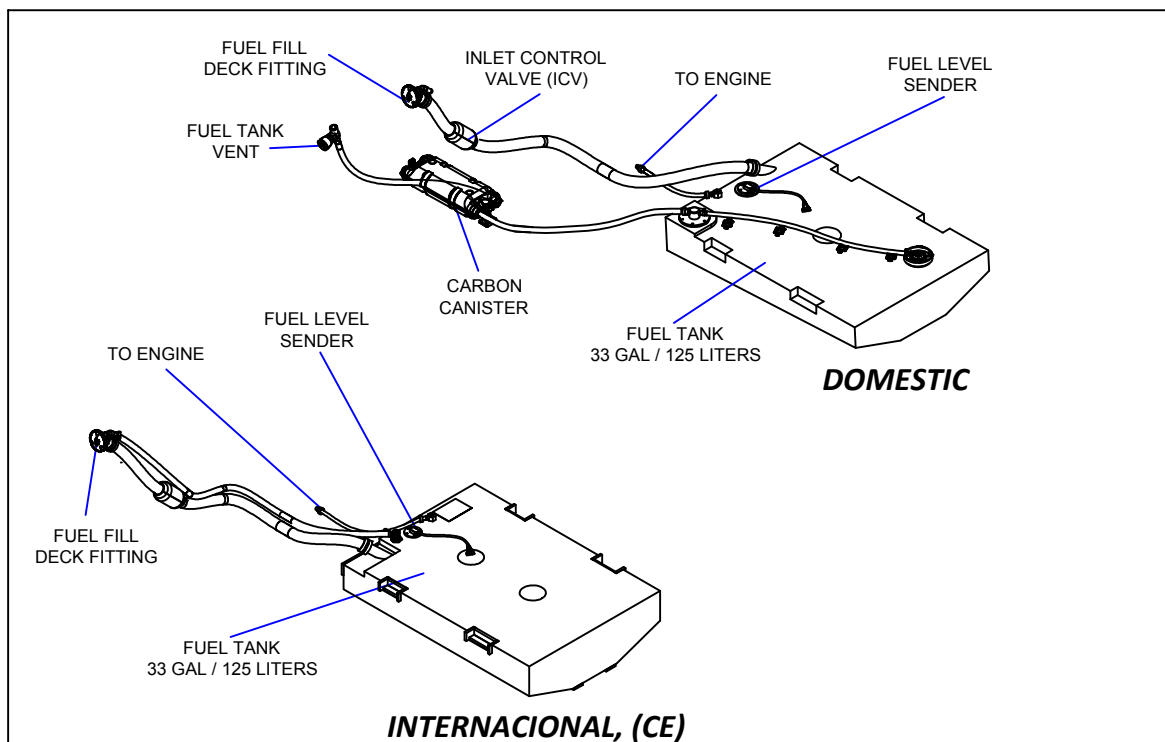

## Fuel Tank Vent and Fuel Fill

Your boat is equipped with a fuel tank vent which serves as a pressure/vacuum release. Periodically check the vents to assure that they are not clogged.

The fuel fill deck fitting is marked GAS. If you have problems filling the fuel tank, see if the fuel fill hose or fuel tank vent hose is kinked or collapsed. If there are no visible signs of a problem, contact your local dealer.

### Anti-Siphon Valve

#### NOTICE

- If an engine running problem is diagnosed as fuel starvation, check the anti-siphon valve.
- If the valve is stuck or clogged, turn Off the engine and then repair or replace the valve.
- Except in an emergency, NEVER run the engine without the anti-siphon valve.

The anti-siphon valve is a vital fuel system part.

If the fuel line ruptures, this valve prevents the siphoning of fuel from the tank. The valve is located on the fuel tank, where the fuel feed line attaches to the tank. The valve is spring loaded and is opened by the fuel pump vacuum.

### Carbon Canister Venting System

Your boat is equipped with a carbon canister. This canister filters all the hydrocarbons that pass through the canister. If the carbon canister is mounted in the engine compartment, the canister will have a heat shield. Periodically check that the shield has not become damaged.

### Fuel Recommendations

The quality of the fuel is very important for satisfactory engine performance and long engine life. Care should be taken to select fuels having the octane rating recommended for the engine, as indicated in the owner's manual, for proper operation. Fuel should be clean and free of contamination. Your fuel tanks should be kept full of fuel whenever possible. This will reduce the amount of water condensation and reduce the possibility of contamination.

When filling the tank, do NOT attempt to top off the tank. When the fill nozzle shuts off, the tank is full. Continuing to fill past the fuel fill shut off will cause the system to spit back.

## ***Bilge Blower System***

The bilge blower system removes explosive fumes from the engine and bilge areas. Fresh air is circulated in the engine and bilge areas through the vents.

 **DANGER**

**EXTREME FIRE and EXPLOSION HAZARD! Fuel vapors can explode**  
BEFORE starting the engine, check the bilge areas for fuel vapors or leaking fuel, If you smell fuel vapors or see leaking fuel:

- Do NOT start the engine
- Do NOT turn On any electrical devices
- Put out all cigarettes, cigars and other sources of flame or ignition
- Get everyone off your boat
- Get trained help to find and fix the problem

After checking for fuel vapors or leaking fuel, properly ventilate the engine and bilge areas. Before starting the engine, electrical system work, or turning on electrical devices, always run the bilge blower for at least four minutes. Continue to run the bilge blower until your boat has reached cruising speed. Always run the bilge blower when running your boat below cruising speed.

- If you smell fuel vapors and the engine is already running:
- Shut Off the engine
- Turn Off all electrical devices
- Put out all cigarettes, cigars and other sources of flame or ignition
- Get trained help to find and fix the problem.

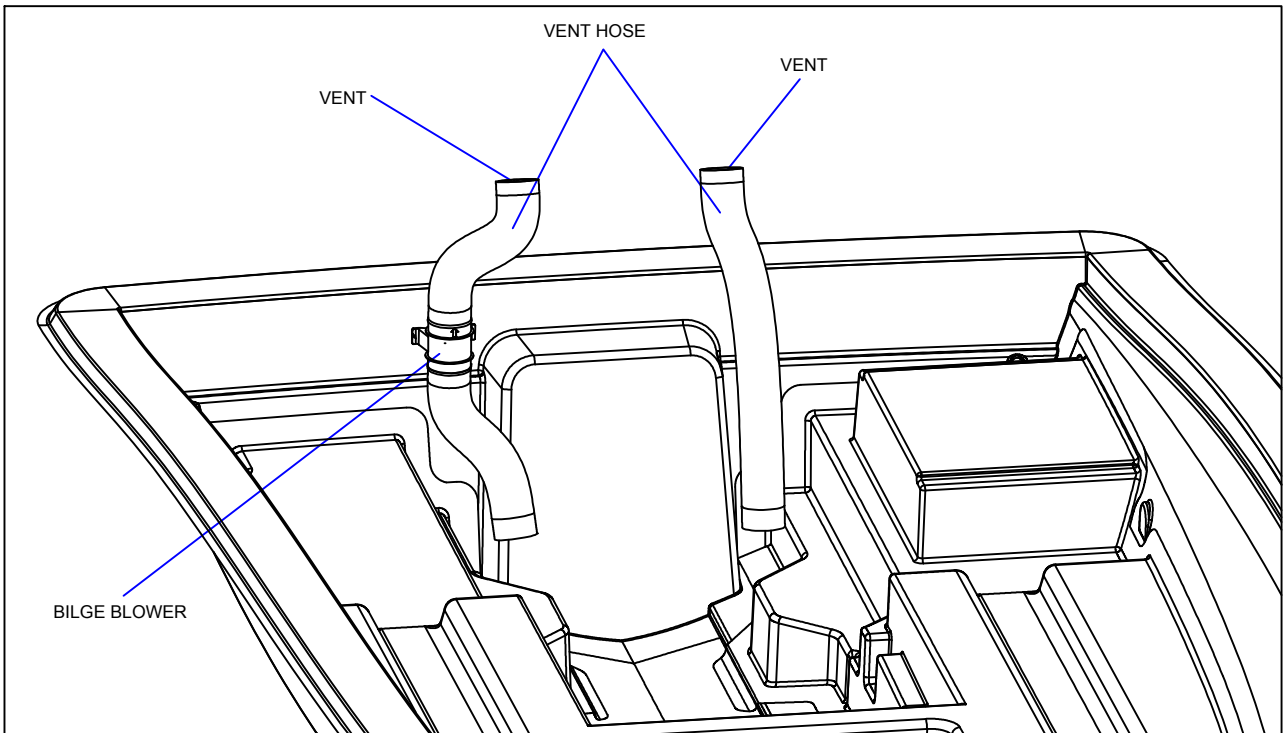

## WARNING

Do not allow obstructions to interfere with the bilge blower or ventilation intake operation. Engine performance may be adversely affected.

## Quick Oil Drain System

The quick oil drain hose assembly was attached to the engine oil pan at the factory. However, some minor assembly is still needed before you can use this system.

**NOTE:** This is not the only method for changing your oil. Your selling dealer can recommend other methods.

How to install the quick oil drain system:

1. Unscrew the factory installed bilge plug from the garboard drain (A).  
**NOTE:** Keep the original factory bilge plug on your boat as a spare.
2. Unclip the quick oil drain assembly from the wire loop (B) on the engine.
3. Unclip the bilge plug's draw cord (C) from the oil drain plug's draw cord (D).
4. Thread the oil drain plug's draw cord (D) through the garboard drain (A).

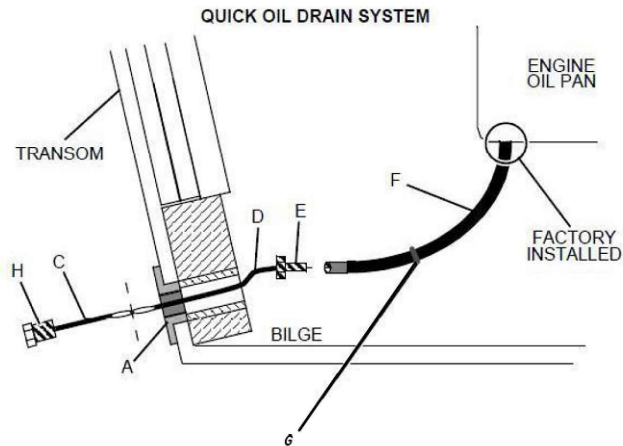

5. Pull the oil drain plug (E), and the oil drain hose (F) through the garboard drain (A).
6. Adjust the hose stop clamp (G) so that no more than 12 inches of hose, including the oil drain plug, can extend out of the garboard drain (A).
7. Clip the bilge plug's draw cord (C) back to the oil drain plug's draw cord (D).
8. Push the oil drain hose, oil drain plug, and both draw cords through the garboard drain and into the bilge area.
9. Screw the bilge plug (H) into the garboard drain (A) and tighten firmly.

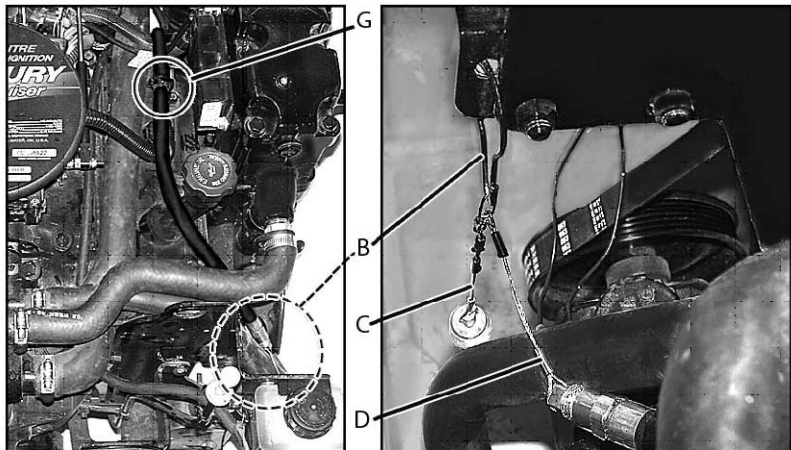

To drain the engine oil:

1. Remove your boat from the water.
2. Unscrew the bilge plug.
3. Pull the draw cord until the oil drain plug and the oil drain hose slide out of the garboard drain.
4. Place the end of the oil drain hose into a suitable container.
5. Unscrew the oil drain plug and drain the engine oil.
6. Replace the oil drain plug.
7. Push the drain hose back into the bilge.
8. Replace the bilge plug and tighten firmly.

**Always dispose of waste oil in accordance with local laws.**



## Chapter 4: Controls and Gauges

---

### Steering

- Boat steering is not self-centering.
- Your boat features a mechanical rack-and-pinion steering.
- Refer to the engine manual for steering system details.

### Shift / Throttle Controls

 <b>WARNING</b>
<b>LOSS OF CONTROL HAZARD !</b> Improper maintenance of the shift/throttle hardware may cause a sudden loss of control.

Read all of the information about the shift/throttle controls in the shift/throttle manual, the engine operation manual, and the *Sport Boat Owner's Manual*.

### Power Trim and Tilt

- The outboard engine on your boat is equipped with power trim and tilt.
- Trim and tilt instructions are provided in the engine operation manual and the shift/throttle manual.

### Gauges

Cleaning the Gauges

 <b>CAUTION</b>
<b>PRODUCT or PROPERTY DAMAGE HAZARD!</b>
<ul style="list-style-type: none"><li>• Use only mild soap and water to clean the gauge lenses and bezels.</li><li>• Use of other cleaners, including common window cleaning solutions, may cause the lenses to crack.</li><li>• Lenses cracked in this manner will NOT be covered by our warranty.</li></ul>

### Gauge Fogging

- Moisture may occasionally find its way into the gauges causing lens fogging.
- Turning On the gauge lights will help dry the lenses.
- Fogging will not harm the gauges.

### Fuel Gauge (On Tank)

It is normal for the pointer on your fuel gauge to bounce as fuel sloshes back and forth in the fuel tank.

## Chapter 5: Navigation Equipment

---

Read the manuals for all navigation and communication equipment before using these systems.

### *Depth Finder (If Equipped)*



#### **WARNING**

- Do NOT use the depth finder as a navigational aid to prevent collision, grounding, boat damage or personal injury.
- When your boat is moving, submerged objects will NOT be seen until they are already under your boat.
- Bottom depths may change too quickly to allow time for your boat to react.
- If you suspect shallow water or submerged objects, run your boat at very slow speeds.

## Chapter 6: Plumbing

### Bilge Pump

Your boat has a bilge pump for pumping water out of the bilge.

#### NOTICE

Discharge of oil, oil waste, or fuel into navigable waters is prohibited by law. Violators are subject to legal action by the local authorities.

- The pump's built-in float switch turns On the bilge pump if bilge water rises above a preset level. Small amounts of water in the bilge are normal.
- You can also turn On the bilge pump using the switch at the helm.
- The bilge pump is wired directly to the battery. Unless the battery is dead, the bilge pump should work even when your boat is unattended.



#### WARNING

The bilge pumping system is not designed for damage control.

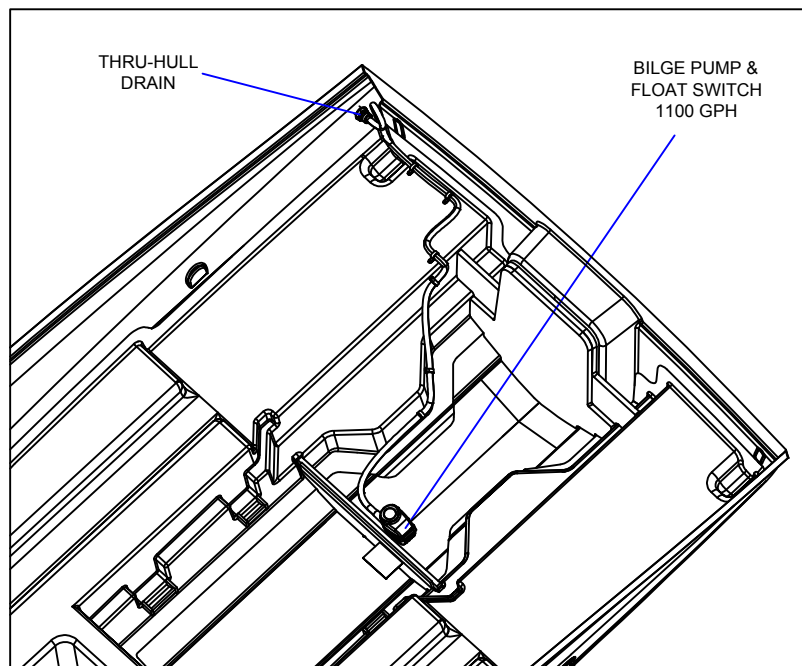

Bilge Pump data:

Sahara S1100 GPH

Nominal voltage rating [V]	- 12
Waterflow at [l/min] 0 kPa [l/min]	- 67,5
Waterflow at [l/min] 10 kPa [l/min]	- 51,7
Waterflow at [l/min] 20 kPa [l/min]	- 38,8

## Bilge Pump Testing

The bilge pump is vital to the safety of your boat. Test the bilge pump often as follows:

1. Turn On the bilge pump switch at the helm.
2. Make sure that water in the bilge is pumped overboard.
3. If there is water in the bilge and the pump motor is running but not pumping water, inspect the discharge hose for a kink or collapsed area.
4. If the discharge hose looks okay, check the bilge pump and strainer for clogging debris.

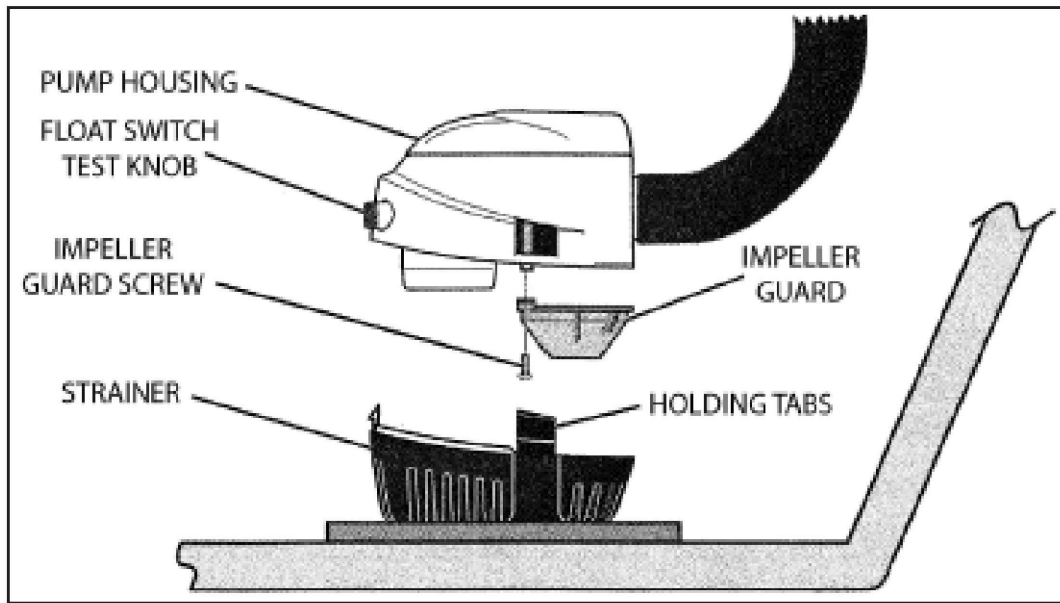

## Drain System

### Deck Drains

Water on the deck is drained overboard through the deck drains. Keep the deck drains free of debris.

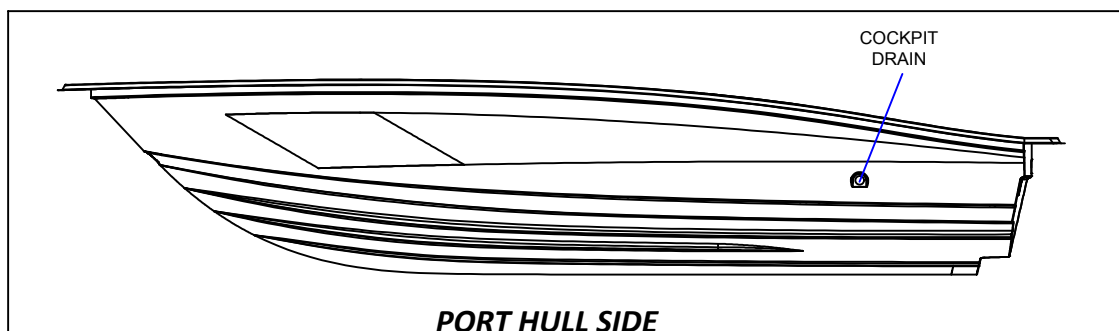
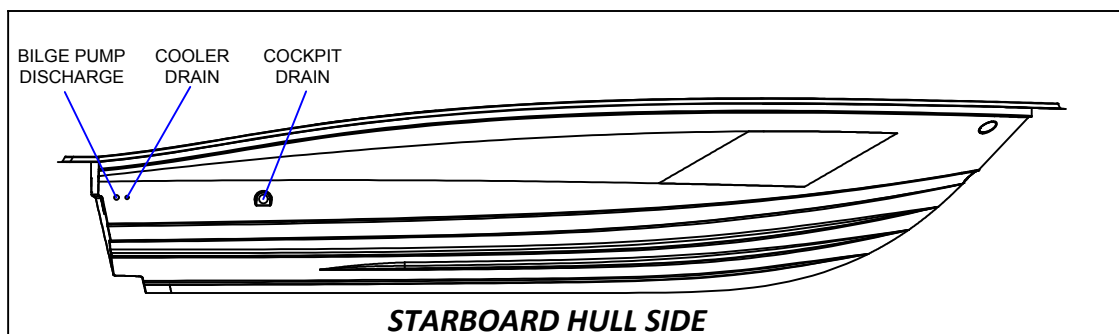

## Chapter 7: Deck Equipment

### Cleats and Bow/Stern Eyes

Cleats must not be used for lifting the boat; they are intended for docking or mooring use only.

**BOW AND STERN EYES:** The bow eye must be used to haul the boat onto a trailer. The stern eyes must be used as tie down points for trailering the boat. The bow and stern eyes may be used for short term lifting of the boat such as for service. Long term lifting with the bow and stern eyes may cause stress on the fiberglass and gel coat.

For long term storage, use flat, wide belt-type slings and spreaders long enough to keep pressure from gunwales. With fiberglass boats, severe gelcoat cracking or more serious hull damage can occur during launching and hauling if pressure is created on the gunwales by the slings. Cable-type slings should be avoided. Do not place the slings where they may lift on underwater fittings.

When lifting the boat, always keep the bow higher than the stern to drain the exhaust lines and to prevent water from running forward through the manifold and into the engine where it can result in water entering the engine cylinders, causing hydrostatic lock and resulting in possible engine failure. Even a small amount of water in the engine can cause rust and is to be avoided.

When towing, always tow or be towed at slow speed. Never exceed the hull speed of a displacement craft when being towed. A tow line shall always be made fast in such a way that it can be released when under load.

Never hoist the boat with an appreciable amount of water in the bilge. Fuel and water tanks should preferably be empty, especially if large capacity. It is the owner's/operators responsibility to ensure that mooring lines, towing lines, anchor chain(s), anchor lines and anchor(s) are adequate for the vessel's intended use, i.e. the lines or chains do not exceed 80 % of the breaking strength of the respective strong point.

Owners should also consider what action will be necessary when securing a tow line on board.

Permissible loads prior Breaking  
Strength of Strong Points:

Cleats and Stern Eyes - 12,83 kN (mooring)

Bow Eye - 24,45 kN (anchoring and towing)

Recommended Mechanical properties of 3- standard hawser-laid synthetic ropes		Nominal Diameter [mm]	Minimum Breaking Strength [kN]	Ultimate Minimum Strength [kN]
Mooring	Polyamide ropes	6	7.35	10.3
	Polyester ropes	8	10.5	
	Polypropylene ropes	8	10.4	
Anchoring and Towing	Polyamide ropes	8	13.2	18.34
	Polyester ropes	10	16.8	
	Polypropylene ropes	10	15.3	

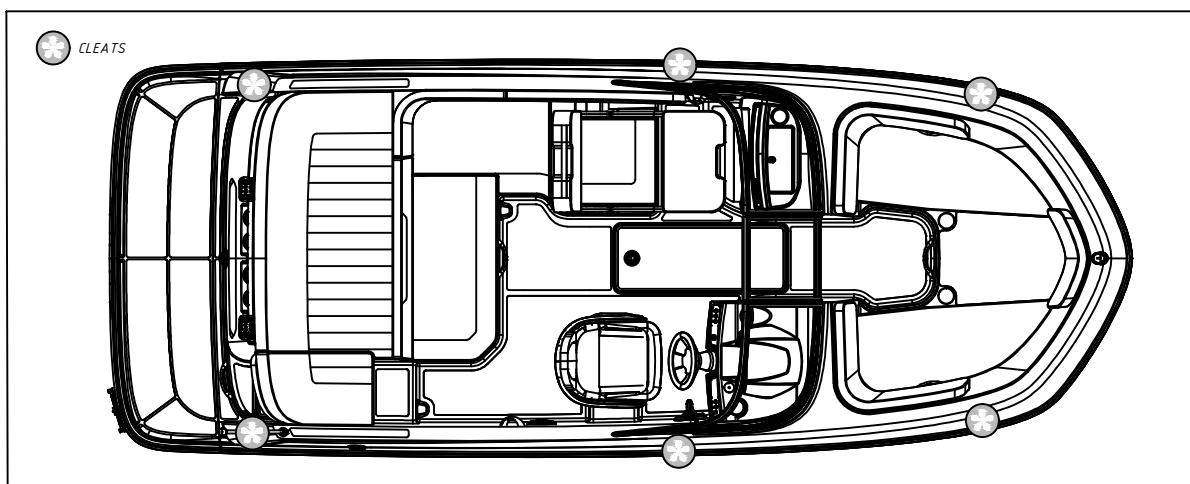

**Ski - Tow Ring****! WARNING****PERSONAL INJURY and/or PRODUCT or PROPERTY DAMAGE HAZARD!**

Failure to follow these guidelines can result in injury or death:

- ONLY tow water skis, wakeboards, or kneeboards.
- Do NOT tow parasail's, kites, tubes, rafts or other boats.
- Do NOT tow more than one person at a time.
- Use caution with skier in tow as tow rope may snap back into cockpit when released.

Attach the ski-tow rope as shown in the photo

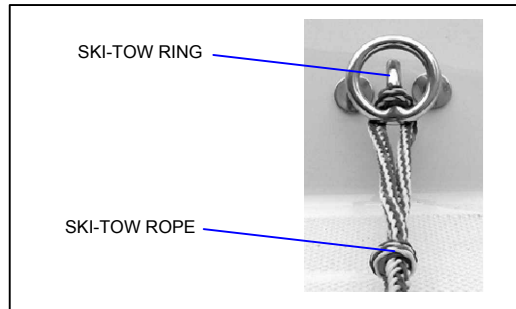
**Ski - Tow Tower (If Equipped)****! WARNING****PERSONAL INJURY and/or PRODUCT or PROPERTY DAMAGE HAZARD!**

- Failure to follow these guidelines can result in injury or death:
- Read ALL warning labels on ski-tow tower.
- BEFORE each use of the boat and BEFORE each use of the folding ski-tow tower, make sure the lock-down bolts are tightened firmly.
- ONLY tow water skis, wakeboards, or kneeboards.
- Do NOT exceed the MAXIMUM tow weight of 400 pounds.
- Do NOT tow parasail's, kites, tubes, rafts or other boats.
- Do NOT tow more than one person at a time.
- Do NOT climb on, sit on, stand on, jump off or dive off tower.
- NEVER allow passengers to sit behind tow rope attachment point.
- Use caution with skier in tow as tow rope may snap back into cockpit when released.
- NEVER allow loose tow rope ends to dangle off tower.
- When tower is up, watch for low obstacles such as tree limbs, bridges, or power lines.

**Attaching the Ski-Tow Rope**

Place the ski-tow rope's loop (A)  
over the ski-tow pylon (B).

Put a twist in the ski-tow rope's loop (A)  
and slide the loop over the ski-tow pylon (B) again.

Pull firmly on the ski-tow rope to tighten.

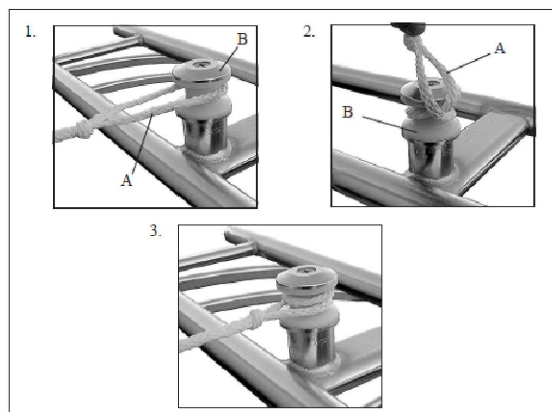

**Canvas****CAUTION****PRODUCT or PROPERTY DAMAGE HAZARD!**

Take down and securely stow ALL canvas and vinyl BEFORE your boat is transported by road.

**NOTICE**

BEFORE cleaning and/or stowing your canvas, read the Canvas Care section, later in this chapter.

**NOTICE**

Two people are needed for most of the tasks listed in this section.

**NOTICE**

Some canvas and vinyl options may not be described. Make sure your dealer explains how to install all canvas and vinyl.

## Canvas Care

- After each use, especially in saltwater, rinse the canvas with cold freshwater.
- Before stowing, let the canvas air-dry completely.
- The canvas can be rolled or folded for stowage.

### Cleaning the Canvas



## CAUTION

NEVER use detergents when washing the canvas. Detergents can destroy the water repellency, and mildew/UV resistant finish of your canvas.

Regularly clean the canvas to prevent dirt, pollen, etc. from embedding in the fabric. Generally, it is easiest to wash the canvas while it is installed on your boat.

1. Use a soft-bristled brush to remove all dust and loose dirt.
2. Hose down the canvas with freshwater.
3. Gently wash the canvas with a solution of lukewarm water (no more than 100° F) and non-detergent mild soap, such as Ivory Snow®, Dreft®, or Woolite®.
4. Rinse thoroughly to remove the soap.
5. Before stowing, let the canvas dry completely.

### Stubborn Stains



## CAUTION

Soaking in bleach solutions may remove the waterproof finish of the fabric and may also decrease the life of the polyester thread used in the canvas. If needed, a water repellent treatment should be reapplied to your canvas. Ask your dealer about the treatments available for your boat's canvas.

Some stubborn stains may resist normal washing and you can try the methods below. However, these methods may remove the waterproof finish of the fabric and may also decrease the life of the polyester thread used in the canvas. Reapply a water repellent treatment as needed.

#### Method 1:

1. Add 1/8 cup (1 oz.) of non-chlorine bleach to one gallon of water and mix thoroughly.
2. Thoroughly wet the canvas and then gently scrub the stained area with the weak bleach solution.
3. Rinse with cold water to remove all of the solution.

#### Method 2:

1. Add 1/2 cup (4 oz.) of non-chlorine bleach and 1/2 cup (4 oz.) Ivory Snow®, Dreft®, or Woolite® to one gallon of water and mix thoroughly.
2. Soak the canvas in this solution for about 20 minutes.
3. Rinse with cold water to remove all of the solution.



## Chapter 8: Entertainment and Appliances System

---

### **Audio System (If Equipped)**

#### **NOTICE**

AM radio reception may be impaired when the engine is running.

Read the manufacturer's instruction manual before using the audio equipment.

### **Automatic Fire Extinguisher System**

Your boat may be equipped with an automatic fire extinguisher system located aft of the engine. In the event of a fire, the heat sensitive automatic head will release the extinguishant as a vapor, totally flooding the area in fire-killing concentrations.

IF ACTUATION OCCURS, IMMEDIATELY SHUT DOWN ALL ENGINES, POWERED VENTILATION, ELECTRICAL SYSTEMS AND EXTINGUISH ALL SMOKING MATERIALS. DO NOT IMMEDIATELY OPEN THE ENGINE COMPARTMENT!! THIS FEEDS OXYGEN TO THE FIRE AND FLASHBACK COULD OCCUR.

Allow the extinguishant to "soak" the compartment for at least fifteen (15) minutes and for hot metals or fuels to cool before cautiously inspecting for cause of fire. Have portable extinguishers at hand and ready. Do not breathe fumes or vapors caused by the fire.

The system indicator light is wired to the ignition and is turned ON when the ignition is turned ON. The indicator light, located on the control station port panel, indicates to the helmsman when the unit has discharged. Under normal circumstances, when the ignition is ON, the charge indicator light is ON. If the unit discharges, the light will go OFF.

### **Manual Fire Extinguishing**

A portable fire extinguisher, in accordance with EN 9094, shall be provided within 2 m from the main helm position of the boat cockpit. The fire extinguisher shall be readily accessible when boat is occupied.

#### **Never:**

- obstruct safety controls, e.g. fuel valves, gas valves, switches of the electrical system,
- obstruct portable fire extinguishers stowed in lockers,
- modify any of the craft's systems (especially electrical, fuel and gas) or allow unqualified personnel to modify any of the craft's systems,
- fill any fuel tank or replace gas bottles when machinery is running, or when cooking or heating appliances are in use,
- smoke while handling fuel or gas.

## Chapter 9: Lights

---

### Care and Maintenance

All of the lights installed on your boat are of top quality, but you should be aware that failure may periodically occur for a variety of reasons:

- There may be a blown fuse - *replace the fuse*.
- The bulb may be burned out - *carry spare replacement bulbs, making sure the wattage is correct*.
- A wire may be damaged or may have come loose - *repair as required*.
- The bulb base may be corroded - *clean the base and coat it with non-conductive electrical lubricant*.

### Interior and Exterior Lights



#### CAUTION

- Be conservative in the use of battery power.
- Prolonged use of cabin interior lights (overnight) WILL result in a drained battery.

- The lights are powered by your boat's 12-Volt DC system.
- The battery switch must be turned On for the lights to work.

### Navigation Lights



#### CAUTION

Avoid the storage of gear where it would block navigation lights from view.

#### NOTICE

Running lights are legally required to show boat direction and right-of-way at night.

Read the navigation light section in the *Sport Boat Owner's Manual*.

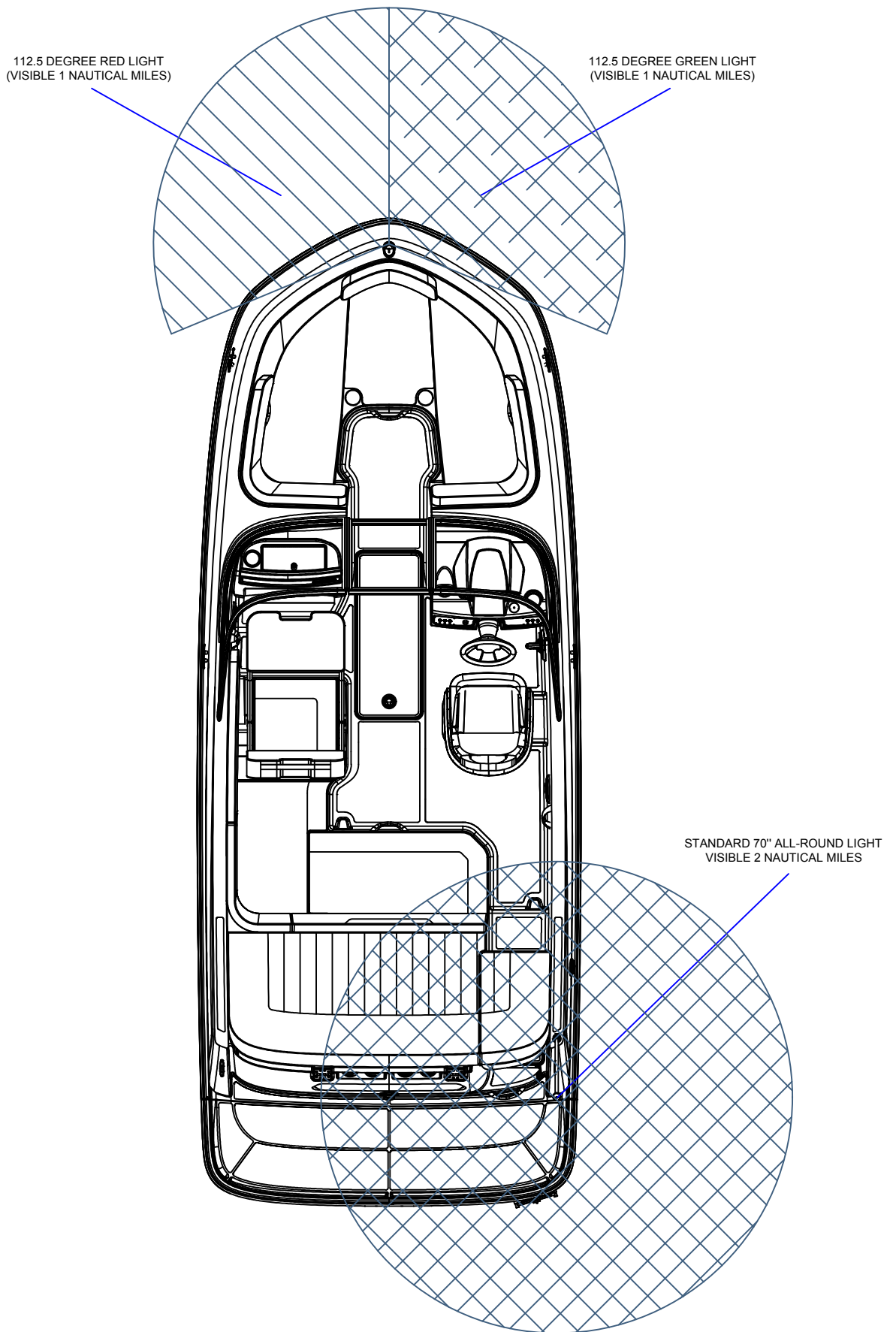

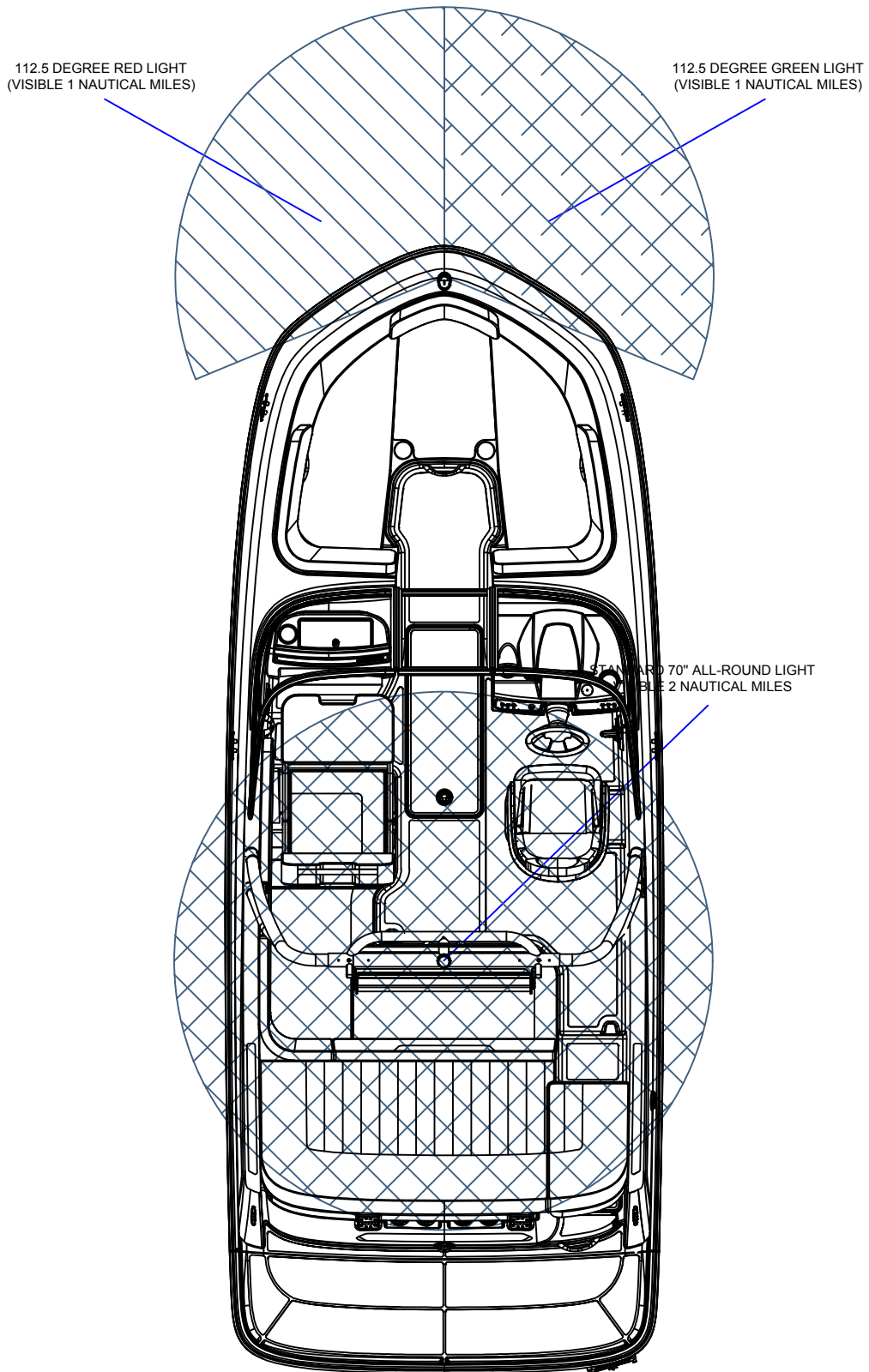

## Chapter 10: Electrical System

---

### **DANGER**

#### **EXTREME FIRE, SHOCK and EXPLOSION HAZARD!**

- NEVER install non-ignition protected switches or other arcing devices in the fuel compartment.
- NEVER substitute automotive parts for marine parts. Marine electrical, ignition, and fuel system parts were designed and manufactured to comply with rules and laws that minimize the risks of fire and explosion.
- NEVER change the electrical systems or relevant drawings.
- Allow ONLY trained personnel to install batteries and/or do electrical system work.
- NEVER work on the electrical system installation while system is energized.
- NEVER leave the craft unattended with the electrical system energized, except automatic bilge pump, fire protection and alarm circuits.
- NEVER install or replace electrical appliances or devices with components which exceed the rated current amperage of the circuit.
- NEVER alter or modify the rated current amperage of overcorrect protective devices.

### **WARNING**

#### **FIRE and EXPLOSION HAZARD!**

Fuel vapors can explode! BEFORE turning on electrical devices or working on the electrical system:

Check the bilge areas for fuel vapors or leaking fuel. If you see leaking fuel or smell fuel vapors:

- Do NOT start the engine, do NOT turn On any electrical devices, put out ALL cigarettes, cigars, and other sources of flame or ignition.
- Get everyone off your boat.
- Get trained help to find and fix the problem.

### **CAUTION**

#### **SHOCK and ELECTRICAL SYSTEM DAMAGE HAZARD!**

When the engine is running, NEVER disconnect the battery cables. Doing so could cause damage to your boat's engine and/or electrical system.

### **NOTICE**

Electrical connections are prone to corrosion. To reduce corrosion-caused electrical problems:

- Keep ALL electrical connections clean.
- Apply a spray-on protectant that is designed to protect connections from corrosion.

## 12-Volt DC System

### Battery

The battery supplies electricity for lights, 12-Volt accessories and engine starting.

The Electrical section in the *Sport Boat Owner's Manual* provides battery care and maintenance instructions.

### Fuses

Replace fuses **ONLY** with a fuse of the same rating. Fuses for the accessories are on the fuse block.

See the Component Locations section in Chapter 2 for the location of the fuse block. Fuses for the engine control and gauges are on the engine. See the engine operation manual.

Some equipment may have secondary fuse protection at the unit or at the battery.

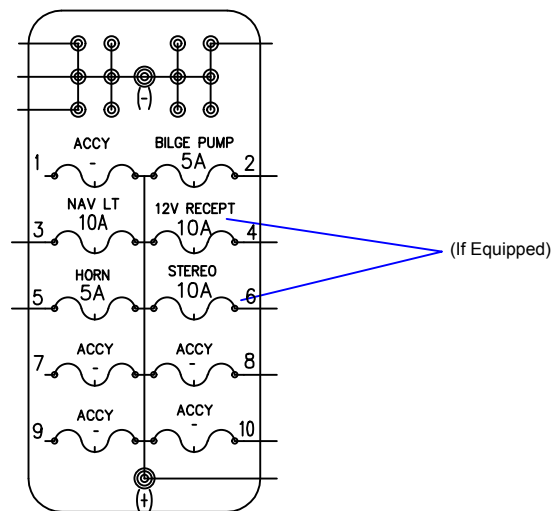

### 12-Volt DC Accessory Outlet (if Equipped)

! **CAUTION**

Do NOT use the 12-Volt DC accessory outlet with a cigarette or cigar lighter. High temperatures may melt the outlet.

- The 12-Volt DC accessory outlet can be used with any 12-Volt device which draws 10-amps or less.
- The 12-Volt DC accessory outlet is protected by a 10-amp fuse on the fuse block.

See the Component Locations section in Chapter 2 for the location of the 12-Volt DC accessory outlet.

### Alternator

The alternator will keep the battery properly charged when the engine is running at, or above, cruising speeds.

# DC Wiring Schematics (1 of 2)

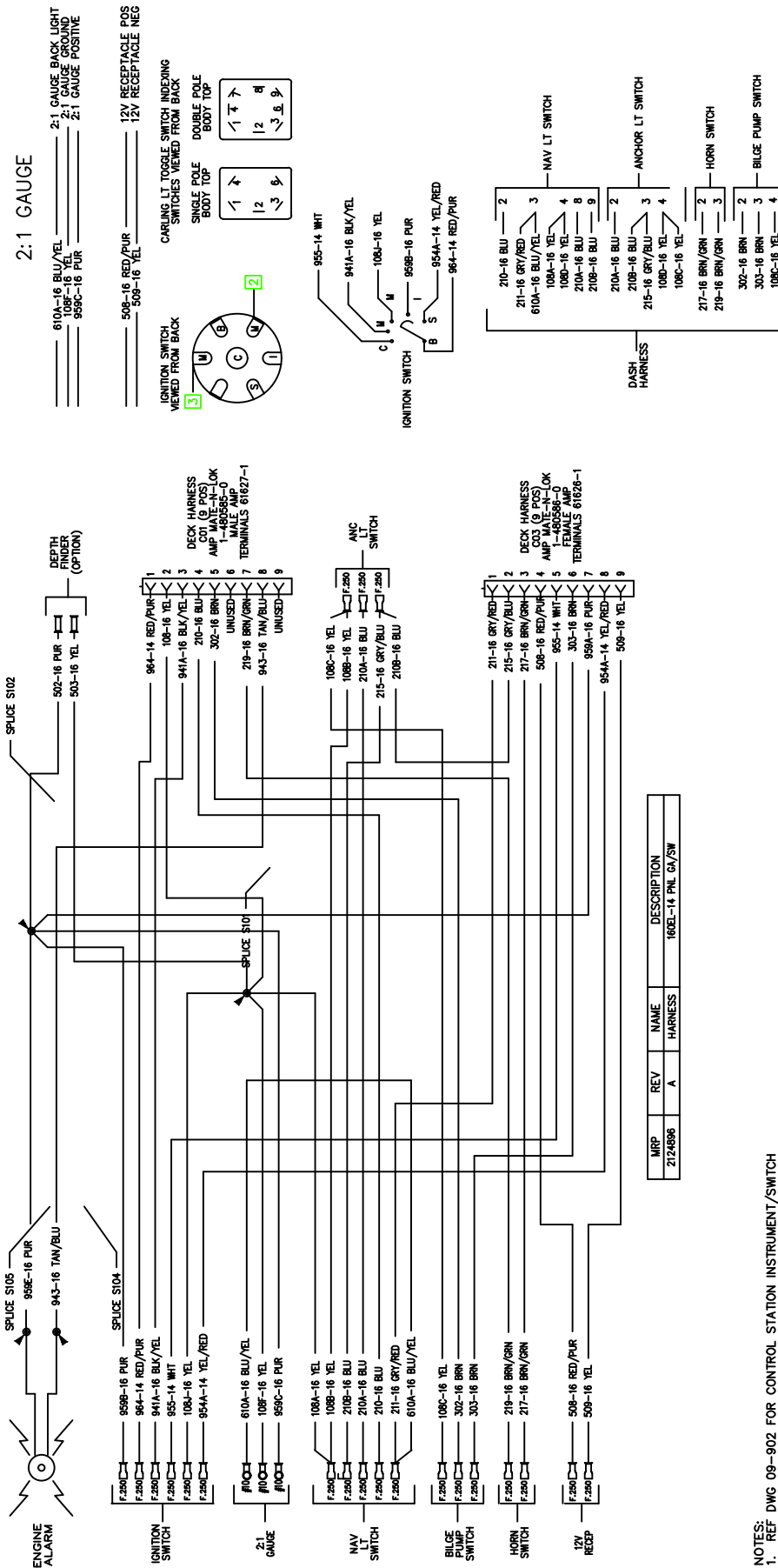

NOTES:  
 DWG 09-902 FOR CONTROL STATION INSTRUMENT/SWITCH PANEL INSTALLATION.  
 1. CONNECT WIRE 108J-16 YEL TO THIS "M" CONNECTOR.  
 2. CONNECT WIRE 941A-16 BLK/YEL TO THIS "M" CONNECTOR.

# DC Wiring Schematics (2 of 2)

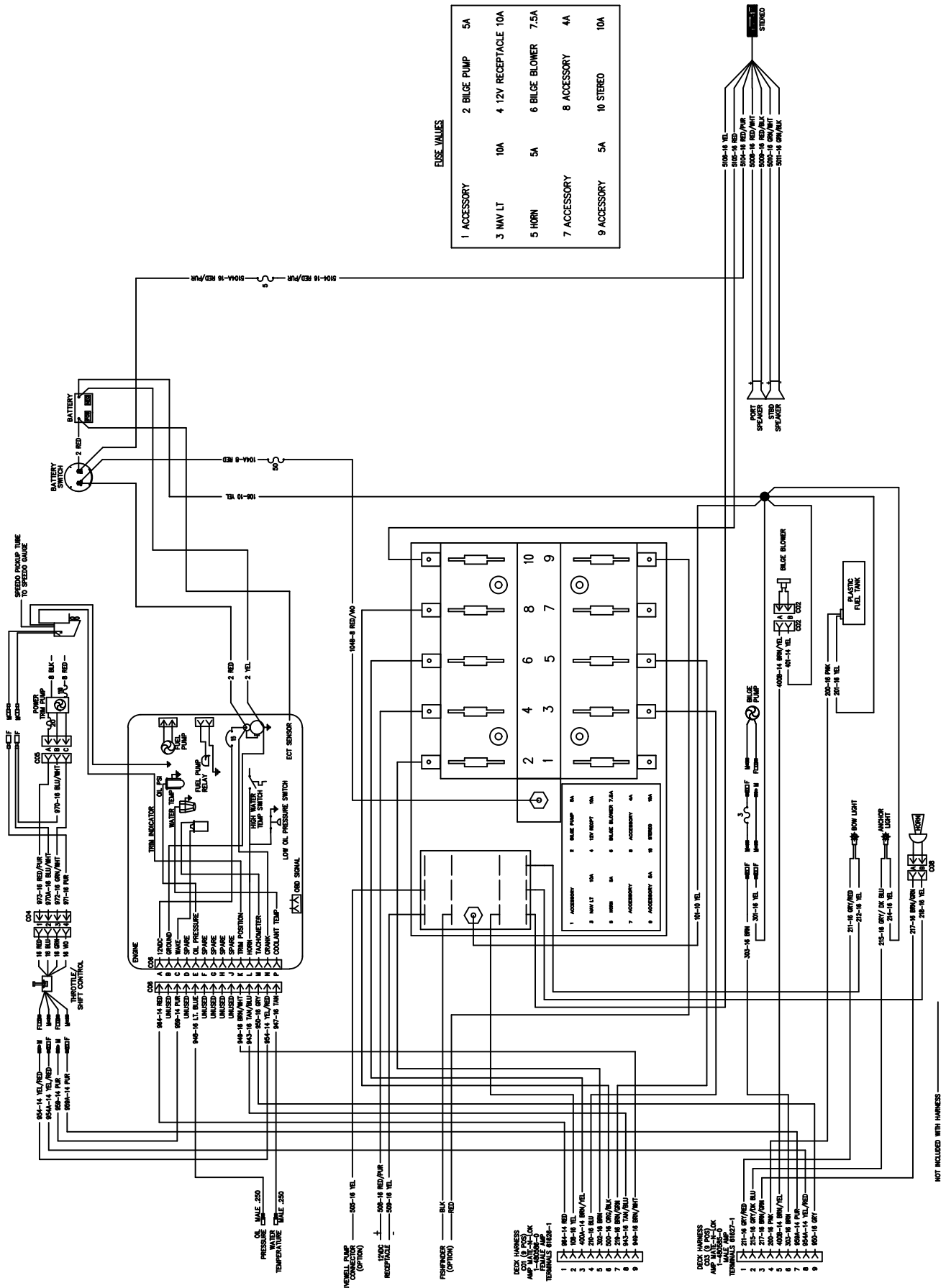



### Electrical Routings

### 12-Volt DC Deck Harnesses

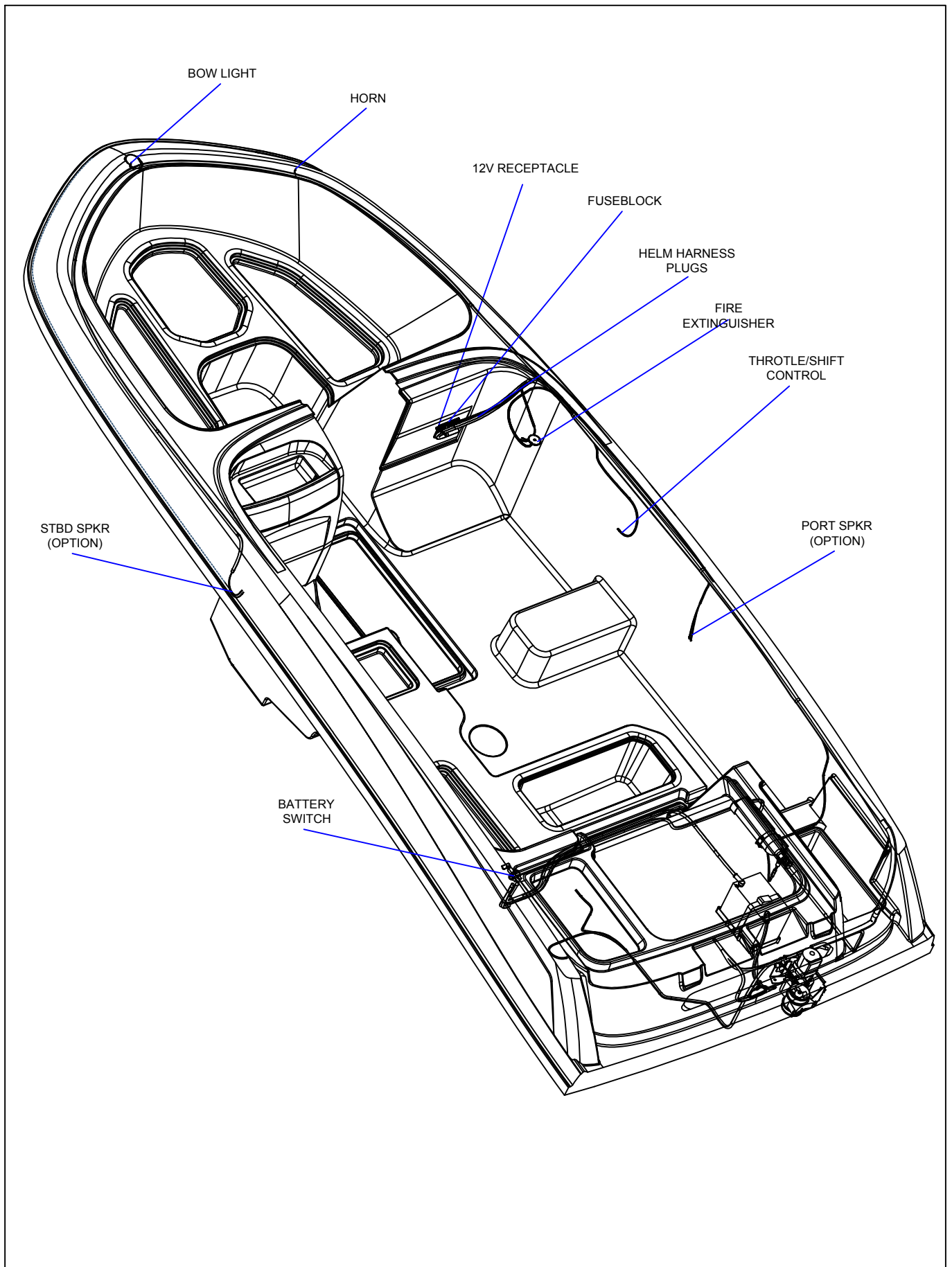

### Battery Cable Routings

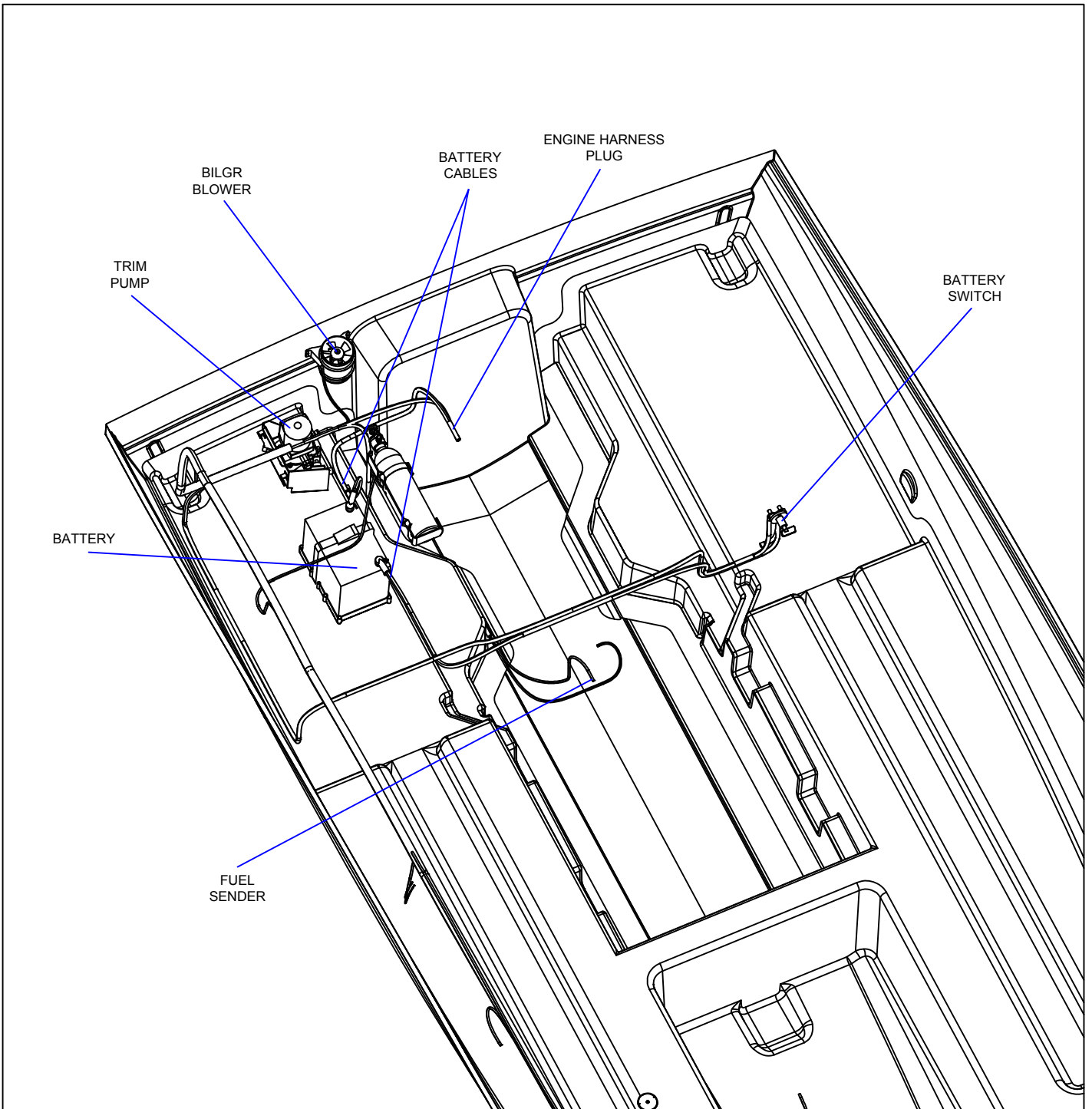



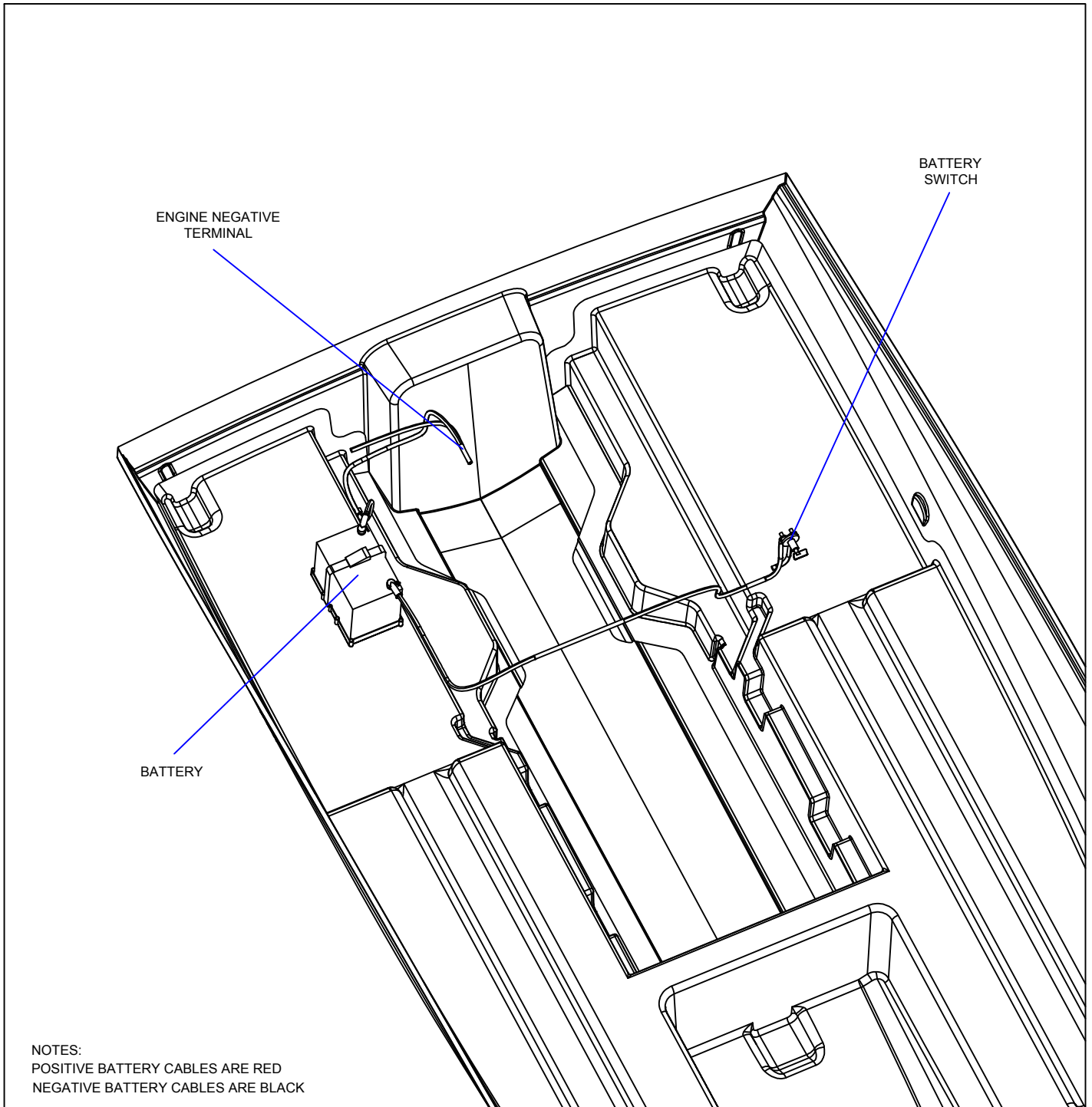





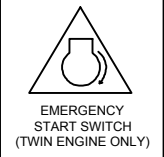
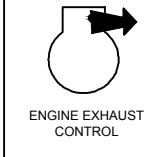
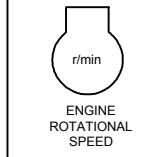
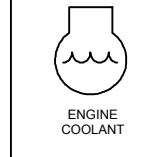
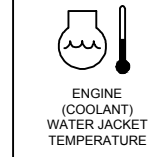
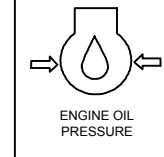
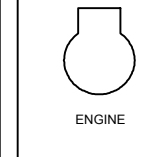
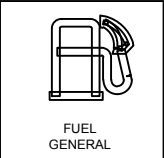
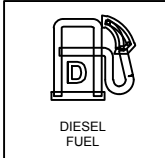
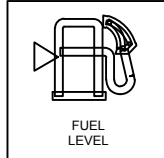
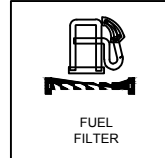
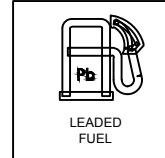
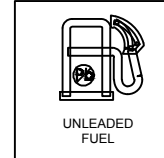
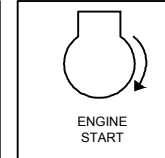

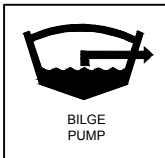
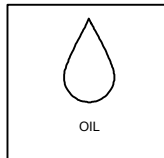
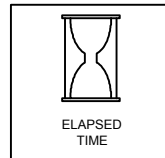
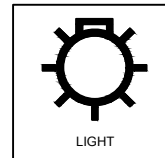
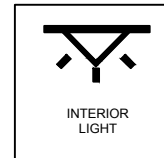
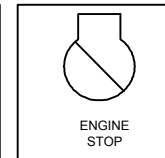

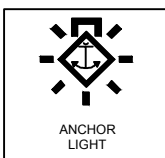
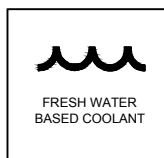
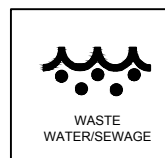
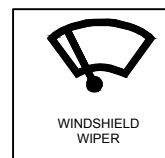

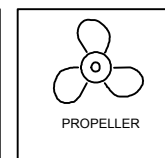
## 12-Volt DC Hull Harnesses

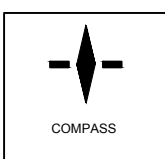
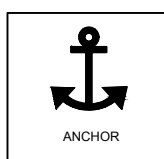

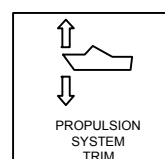
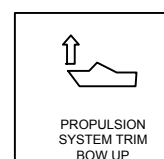
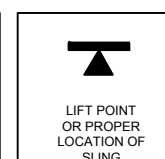
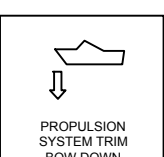
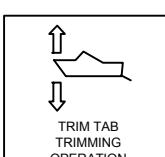
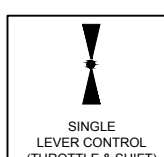
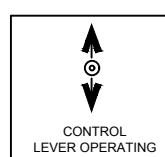
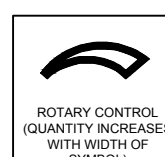
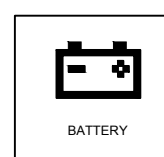
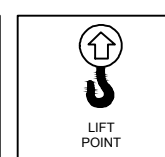
## Key to symbols controls prints

These symbols may be found on your controls and gauges and/or used in this owner's manual. This page is to help you understand what the symbols mean.

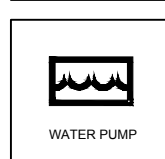
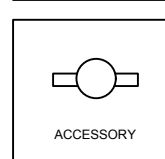
 EMERGENCY START SWITCH (TWIN ENGINE ONLY)	 ENGINE EXHAUST CONTROL	 ENGINE ROTATIONAL SPEED	 ENGINE COOLANT	 ENGINE (COOLANT) WATER JACKET TEMPERATURE	 ENGINE OIL PRESSURE	 ENGINE
 FUEL GENERAL	 DIESEL FUEL	 FUEL LEVEL	 FUEL FILTER	 LEADED FUEL	 UNLEADED FUEL	 ENGINE START
 BILGE BLOWER	 BILGE PUMP	 OIL	 ELAPSED TIME	 LIGHT	 INTERIOR LIGHT	 ENGINE STOP
 RUNNING LIGHTS UNDER POWER	 ANCHOR LIGHT	 FRESH WATER BASED COOLANT	 WASTE WATER/SEWAGE	 WINDSHIELD WIPER	 WINDSHIELD WASHER	 PROPELLER
 WINDSHIELD WIPER AND WASHER	 COMPASS	 ANCHOR	 HORN	 PROPULSION SYSTEM TRIM	 PROPULSION SYSTEM TRIM BOW UP	 LIFT POINT OR PROPER LOCATION OF SLING
 PROPULSION SYSTEM TRIM BOW DOWN	 TRIM TAB TRIMMING OPERATION	 SINGLE LEVER CONTROL (THROTTLE & SHIFT)	 CONTROL LEVER OPERATING DIRECTION	 ROTARY CONTROL (QUANTITY INCREASES WITH WIDTH OF SYMBOL)	 BATTERY	 LIFT POINT
 WARNING ELECTRICAL HAZARD	 FIRE RISK	 NO OPEN FLAME NO SMOKING	 WATER PUMP	 ACCESSORY		

# Important Records

---

## Selling Dealer

\_\_\_\_\_  
Name Of Dealership

\_\_\_\_\_  
Address

\_\_\_\_\_  
Phone/FAX/E-mail

\_\_\_\_\_  
Sales Manager

\_\_\_\_\_  
Service Manager

## Engine

\_\_\_\_\_  
Manufacturer

\_\_\_\_\_  
Model Name/Number

\_\_\_\_\_  
Engine Serial Number

\_\_\_\_\_  
Oil Type/SAE

\_\_\_\_\_  
Quarts per Engine

\_\_\_\_\_  
Filter Type

## Propeller

\_\_\_\_\_  
Manufacturer

\_\_\_\_\_  
Pitch

\_\_\_\_\_  
Model Number

## Key Numbers

\_\_\_\_\_  
Ignition

\_\_\_\_\_  
Other

## Electronics

_____ Manufacturer	_____ Model Name/Number
_____ Serial Number	
_____ Manufacturer	_____ Model Name/Number
_____ Serial Number	
_____ Manufacturer	_____ Model Name/Number
_____ Serial Number	
_____ Manufacturer	_____ Model Name/Number
_____ Serial Number	
_____ Manufacturer	_____ Model Name/Number
_____ Serial Number	
_____ Manufacturer	_____ Model Name/Number
_____ Serial Number	

# Float Plan

Before going boating, fill out a copy of this float plan (or similar) and leave it with a **reliable** person whom you can depend on to contact the Coast Guard or other rescue organization, if you do not return as scheduled.

## Description of Boat

Registration/Documentation Number			Full Name		
Length	Make	Type	Male or Female	Age	Health
Hull Color		Trim Color		Full Name	
Fuel Capacity	Engine Type	Number of Engines	Male or Female	Age	Health
Distinguishing Features			Full Name		
Distinguishing Features			Male or Female	Age	Health
Distinguishing Features			Full Name		
Distinguishing Features			Male or Female	Age	Health

## Operator of Boat

Full Name			Full Name		
Male or Female	Age	Health	Male or Female	Age	Health
Address			Full Name		
Address			Male or Female	Age	Health
Phone/FAX/E-mail			Full Name		
Operator's Experience			Male or Female	Age	Health
Operator's Experience			Full Name		
Operator's Experience			Male or Female	Age	Health

## Persons Onboard

Full Name			Full Name		
Male or Female	Age	Health	Male or Female	Age	Health
Full Name			Full Name		
Male or Female	Age	Health	Male or Female	Age	Health

## Survival Equipment

Marine Radio (Yes/No)	Type	Frequencies
Number of PFDs	Flares (Yes/No)	Mirror (Yes/No)
Smoke Signal (Yes/No)	Flashlight (Yes/No)	Food (Yes/No)
Water (Yes/No)	Anchor (Yes/No)	Raft/Dinghy (Yes/No)
Paddles (Yes/No)	EPIRB (Yes/No)	Other
Other	Other	Other

## Trip Expectations

Departing From	
Departing Date	Departing Time
Stopover 1	
Arrive No Later Than: Date	Arrive No Later Than: Time
Stopover 2	
Arrive No Later Than: Date	Arrive No Later Than: Time
Stopover 3	
Arrive No Later Than: Date	Arrive No Later Than: Time
Stopover 4	
Arrive No Later Than: Date	Arrive No Later Than: Time
Stopover 5	
Arrive No Later Than: Date	Arrive No Later Than: Time
Stopover 6	
Arrive No Later Than: Date	Arrive No Later Than: Time
Final Destination Port (If Different Than Home Port)	
Arrive No Later Than: Date	Arrive No Later Than: Time

## Vehicle Description

Make	Model
Color	License Number
Where is the Vehicle Parked?	

**If not returned by the date and time listed above, call the Coast Guard or other local authority.**

Coast Guard Phone Number
Local Authority Phone Number

**BAYLINER®**

[www.bayliner.com](http://www.bayliner.com)